

STIEBEL ELTRON SOM 9s

Simply the Best

Installation

Operation

Functions and options

Troubleshooting



SOM 9s



49012850

**Thank you for buying this product.
Read this manual carefully to get the best performance from this unit.
Please keep this manual carefully.**

en-US/CA
Manual

Contents

1 Overview	3	6 Functions and options	75
2 Installation	4	6.1 Status level.....	75
2.1 Mounting.....	4	6.2 Adjustment channels.....	78
2.2 Electrical connection.....	4	6.3 Overview of options and their parameters....	94
2.3 Data communication / Bus	6	7 User code and short menu -	
2.4 SD card slot	6	Adjustment values	96
2.5 Overview of the systems	7	8 Messages	97
2.6 System layouts	9	9 Troubleshooting	98
3 Operation and function	69	9.1 Miscellaneous.....	99
3.1 Buttons.....	69	10 Accessories	101
3.2 Selecting menu points and adjusting values ...	69	10.1 Sensors and measuring instruments.....	101
3.3 Menu structure.....	69	10.2 Interface adapters.....	101
3.4 Indications and system monitoring display.....	70	10.3 Visualization modules	102
3.5 Further indications	71	11 Index	103
4 Status menu	72		
5 Initial commissioning	73		

Subject to technical change. Errors excepted.

General

Safety advice:

Please read the following information carefully before installing and operating the controller. In this way damage to the solar system caused by wrong installation will be avoided. Please make sure that the mounting is adapted to the characteristics of the building, that the local regulations are respected and is conform with the technical rules.

Please pay attention to the following safety advice in order to avoid danger and damage to people and property.

Instructions:

Attention should be paid to

- Valid national and local standards and regulations
- Respective valid standards and directives

Equipment to be installed and used in accordance with the rules of the National Electrical Code (NEC) or with Canadian Electrical Code (CEC), Part I.

These instructions are exclusively addressed to authorized skilled personnel.

- Only qualified electricians should carry out installation and maintenance work.
- Initial installation should be carried out by qualified personnel

Description of symbols

WARNING!	Warnings are indicated with a warning triangle!
	They contain information on how to avoid the danger described.

Signal words describe the danger that may occur, when it is not avoided.

WARNING means that injury, possibly life-threatening injury, can occur.

ATTENTION means that damage to the appliance can occur.

**Note**

Notes are indicated with an information symbol.

→ Arrows indicate instruction steps that should be carried out.

Information about the product

Proper usage

The solar controller is designed for use in solar thermal and heating systems in compliance with the technical data specified in these instructions.

Improper use excludes all liability claims.

**Note**

Strong electromagnetic fields can impair the function of the controller.

- Make sure the controller as well as the system are not exposed to strong electromagnetic fields.

1 Overview



- Extra large graphic display
- 4 relay outputs
- 7 sensor inputs, 2 of them for Grundfos Direct Sensors™
- 2 PWM outputs for speed control of high-efficiency pumps
- Data logging onto SD card
- Drainback option
- Time-controlled thermostat function
- VBus®
- Energy-saving switch-mode power supply

Included:

- 1 x SOM 9s
- 1 x accessory bag
- 3 x screw and wall plug
- 8 x strain relief and screw

Additionally included in the full kit:

- 2 x FKP6 sensor
- 2 x FRP6 sensor



Note:

For more information about accessories, see p. 101.



Note:

The SD card is not included with the controller

Technical data

Housing:

plastic, PC-ABS and PMMA

Protection type: IP 20 / EN 60 529

Protection class: I

Ambient temp.: 32...104 °F

Dimensions: 204 x 170 x 47 mm

Mounting: wall mounting, also suitable for mounting into patch panels

Display: System-Monitoring-Display for system visualization, 16-segment display, 7-segment display, 8 symbols, control lamp (directional pad) and background illumination

Operation: 7 push buttons at the front of the housing

Functions: System controller for solar and heating systems. Functions such as: ΔT control, pump speed control, energy metering, operating hours counter for the solar pump, evacuated tube collector function, thermostat function, vertical tank loading, priority logic, drainback option, booster function, heat dump function, thermal disinfection function, PWM pump control.

Inputs:

5 inputs for Pt1000 temperature sensors, inputs for 1 Grundfos Direct Sensor™ VFS and 1 Grundfos Direct Sensor™ RPS, 1 Impulse input V40

Outputs:

3 semiconductor relays, 1 standard relay, 2 PWM outputs

Interfaces: VBus®, SD card slot

Power supply:

100 ... 240V~, 50 ... 60Hz

Switching capacity per relay:

- 1 (1) A 100 ... 240V~ (semiconductor relay)
- 2 (1) A 100 ... 240V~ (standard relay)

Total switching capacity: 4 A

Standby power consumption: < 1W

Mode of operation: type 1.Y

2 Installation

2.1 Mounting

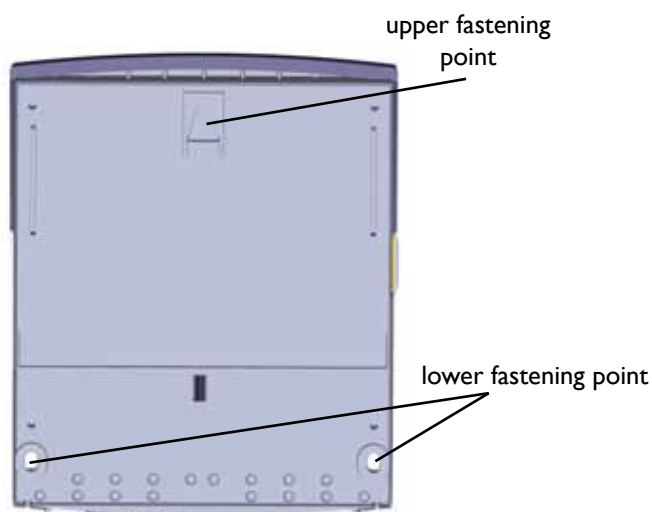
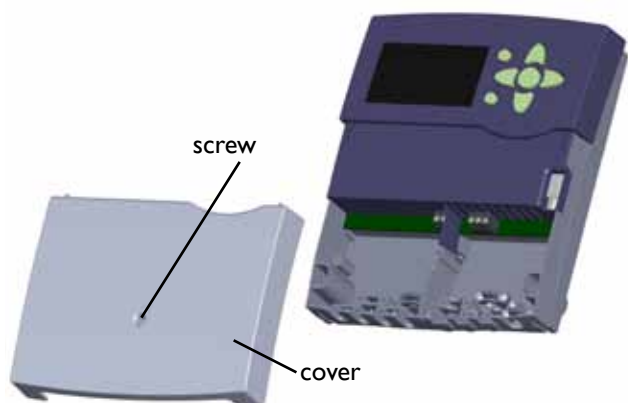

WARNING!	Electric shock! Upon opening the housing, live parts are exposed. → Always disconnect the controller from power supply before opening the housing!



Note
Strong electromagnetic fields can impair the function of the controller.

→ Make sure the controller as well as the system are not exposed to strong electromagnetic fields.

The unit must only be located in dry interior rooms.

The controller must additionally be supplied from a double pole switch with contact gap of at least 3 mm.

Please pay attention to separate routing of sensor cables and power supply cables.

In order to mount the device to the wall, carry out the following steps:

- Unscrew the cross-head screw from the cover and remove it along with the cover from the housing
- Mark the upper fastening point on the wall. Drill and fasten the enclosed wall plug and screw leaving the head protruding
- Hang the housing from the upper fastening point and mark the lower fastening points (centres 150 mm)
- Insert lower wall plugs
- Fasten the housing to the wall with the lower fastening screws and tighten
- Carry out the electrical wiring in accordance with the terminal allocation, see chap. 2.2
- Put the cover on the housing
- Attach with the fastening screw

2.2 Electrical connection

ATTENTION!	ESD damage! Electrostatic discharge can lead to damage to electronic components! → Take care to discharge properly before touching the inside of the device! To do so, touch a grounded surface such as a radiator or tap!



Note:

The pump speed must be set to 100 % when auxiliary relays or valves are connected.

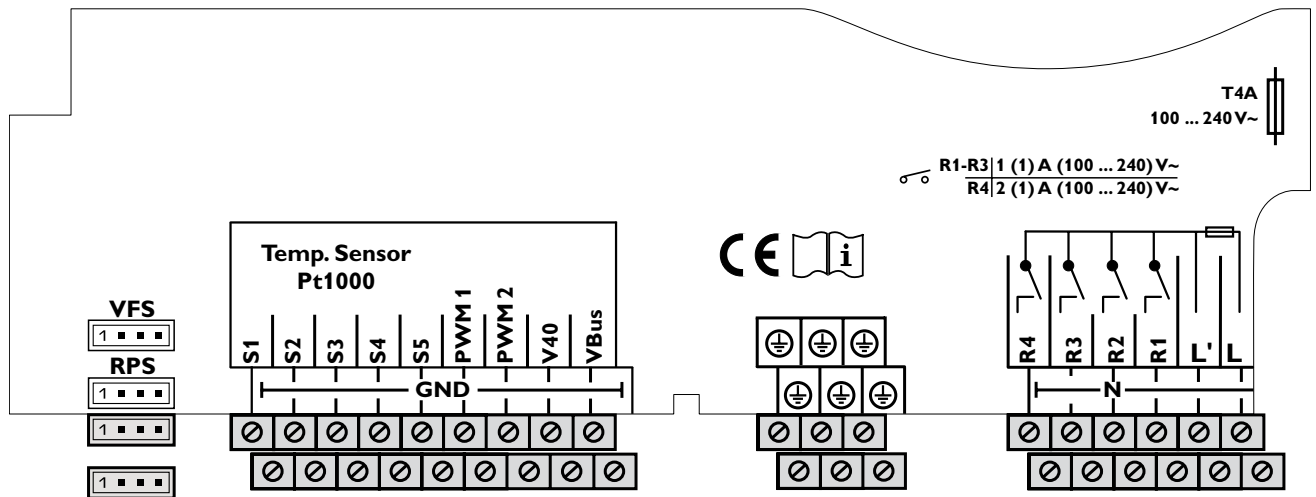

WARNING!	Electric shock! Upon opening the housing, live parts are exposed. → Always disconnect the controller from power supply before opening the housing!

	Note: Connecting the device to the power supply must always be the last step of the installation!
--	---

	Note: The connection depends on the system selected, see chap. 2.6. "System layouts"
--	--

WARNING!	Electric shock! L' is a fused contact permanently carrying voltage → Always disconnect the controller from power supply before opening the housing!

	Note: For more details about the initial commissioning procedure, see chap. 5, page 73.
--	---

The controller is supplied with power via a power supply cable. The power supply of the device must be 100...240V~ (50...60 Hz).

The controller is equipped with 4 relays in total to which loads such as a pump, a valve, etc. can be connected:

- Relays R1 ... R3 are semiconductor relays, designed for pump speed control

Conductor R1... R3

Neutral conductor N

Ground terminal

- Relay 4 is a standard relay

Conductor R4

Neutral conductor N

Ground terminal

Depending on the product version, power supply cable and sensor cables are already connected to the device. If that is not the case, please proceed as follows:

Connect the **temperature sensors** (S1 to S5) to the corresponding terminals with either polarity:

S1 = sensor 1 (collector sensor)

S2 = sensor 2 (e. g. tank sensor bottom)

S3 = sensor 3 (e. g. tank sensor top)

S4 = sensor 4 (e. g. tank sensor tank 2)

S5 = sensor 5 (e. g. collector sensor collector 2)

Connect the **Grundfos sensors** to the VFS and RPS inputs.

A **V40 flowmeter** can be connected to the terminals V40 and GND (either polarity).

The terminals marked "**PWM**" are control outputs for a high-efficiency pump (PWM1 is allocated to R1 and PWM2 is allocated to R2).

The **power supply connection** is at the terminals:

Neutral conductor N

Conductor L

Conductor L' (L' is not connected with the power supply cable. L' is a fused contact permanently carrying voltage)

Ground terminal

2.3 Data communication / Bus

The controller is equipped with the **VBus®** for data transfer with and energy supply to external modules. The connection is carried out at the two terminals marked “VBus” and GND (any polarity). One or more VBus® modules can be connected via this data bus, such as:

- GA3 Large display module / Smart Display SD3
- AM1 Alarm module
- DL2 Datalogger

Furthermore, the controller can be connected to a PC via the VBus®/USB or VBus®/LAN interface adapter (not included with the SOM 9s). With the ServiceCenter Software (RSC), measured values can be read, processed and visualized. The software allows easier function control and adjustment of the system.



Note:

For more information about accessories, see p. 101.

2.4 SD card slot



The controller is equipped with an SD card slot for storing system data onto an SD card. The values can be opened and visualized, e. g. in a spreadsheet programme.



Note:

Do not use an SD-HC card!

A standard SD card is not included with the SOM 9s.

For more information about using an SD card, see chap. 6.2 (page 93) “SD card“.

2.5 Overview of the systems

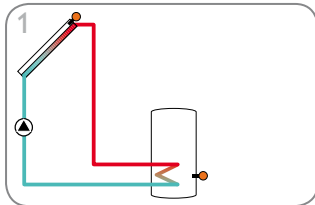

Standard solar system with 1 tank (page 9)

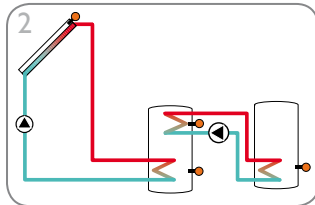

Solar system with 2 tanks and heat exchange (page 11)

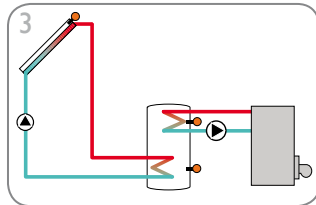

Solar system with 1 tank and backup heating (page 13)

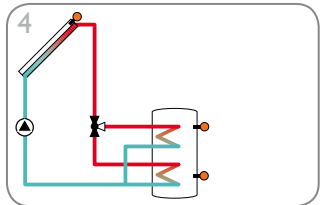

Solar system with 1 tank and 3-port valve for vertical tank loading (page 15)

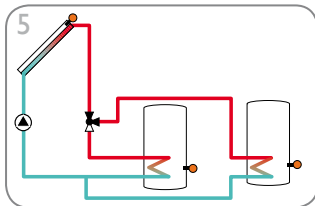

2-tank system with valve logic, 1 pump, 3 sensors and 3-port valve (page 17)

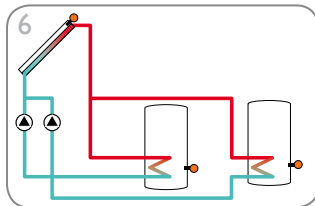

2-tank solar system with pump logic (page 19)

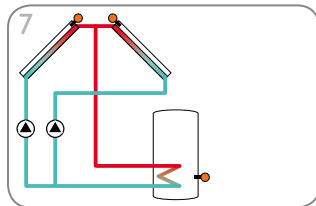

Solar system with east-/west collectors (page 21)

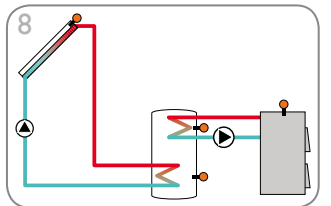

Solar system with 1 tank and backup heating with solid fuel boiler (page 23)

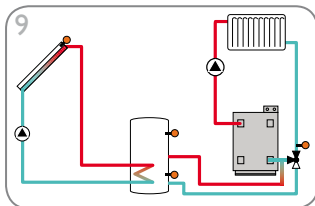

Solar system with 1 tank and heating circuit return preheating (page 25)

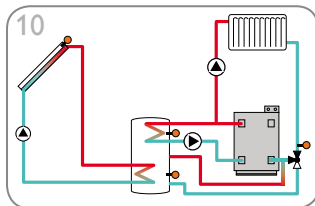

Solar system with 1 tank, heating circuit return preheating and thermostatic backup heating (page 27)

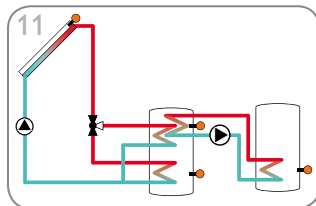

Solar system with vertical tank loading and heat exchange control (page 29)

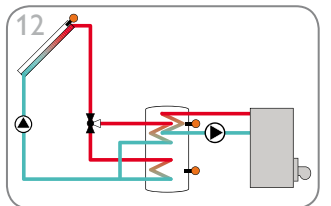

Solar system with vertical tank loading and thermostatic backup heating (page 31)

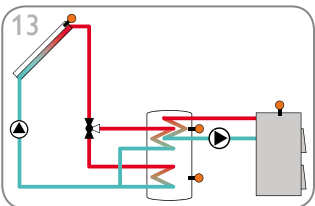

Solar system with vertical tank loading and backup heating with solid fuel boiler (page 33)

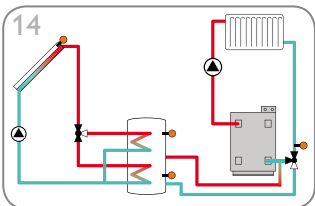

Solar system with vertical tank loading and return preheating (page 35)

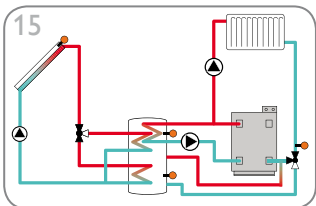

Solar system with vertical tank loading and backup heating with heating backup (page 37)

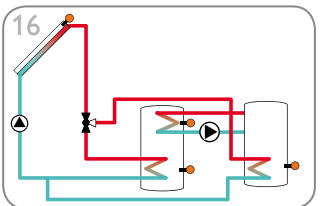

2-tank solar system with valve logic and heat exchange control (page 40)

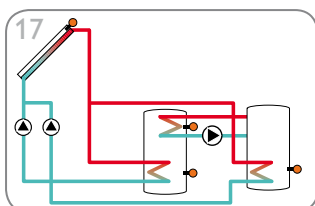

2-tank solar system with pump logic and heat exchange control (page 42)

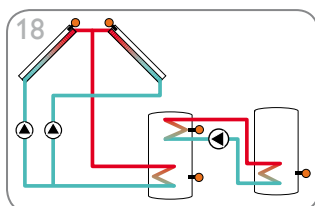

Solar system with east-/west collectors and heat exchange control (page 45)

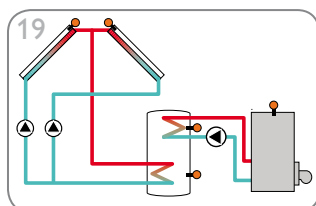

Solar system with east-/west collectors and thermostatic backup heating (page 47)

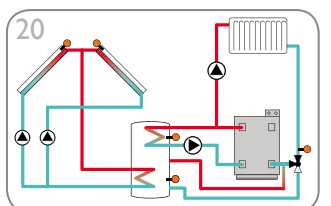

Solar system with east-/west collectors, thermostatic backup heating and return preheating (page 49)

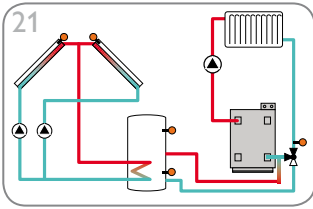

Solar system with east-/west collectors and heating circuit return preheating (page 51)

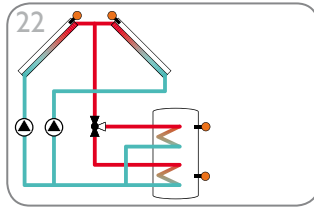

Solar system with vertical tank loading and east-/west collectors (page 53)

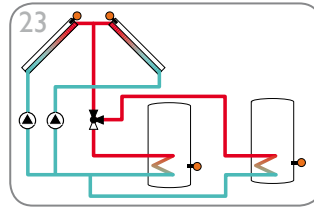

Solar system with east-/west collectors and 2 tanks (valve logic) (page 56)

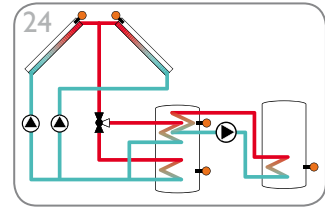

Solar system with east-/west collectors, vertical tank loading and heat exchange (page 59)

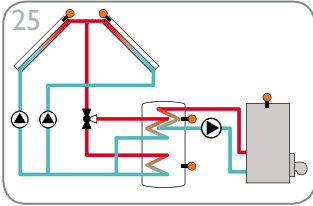

Solar system with east-/west collectors, vertical tank loading and and thermostatic backup heating (page 62)

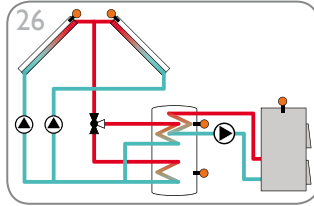

Solar system with east-/west collectors, vertical tank loading and backup heating with solid fuel boiler (page 65)

2.6 System layouts

System 1

Standard solar system with 1 tank

The controller calculates the temperature difference between collector sensor S1 and tank sensor S2. If the difference is larger than or identical to the adjusted switch-on

temperature difference, the pump (R1) will be switched on and the tank will be loaded until the switch-off temperature difference or the maximum tank temperature is reached.

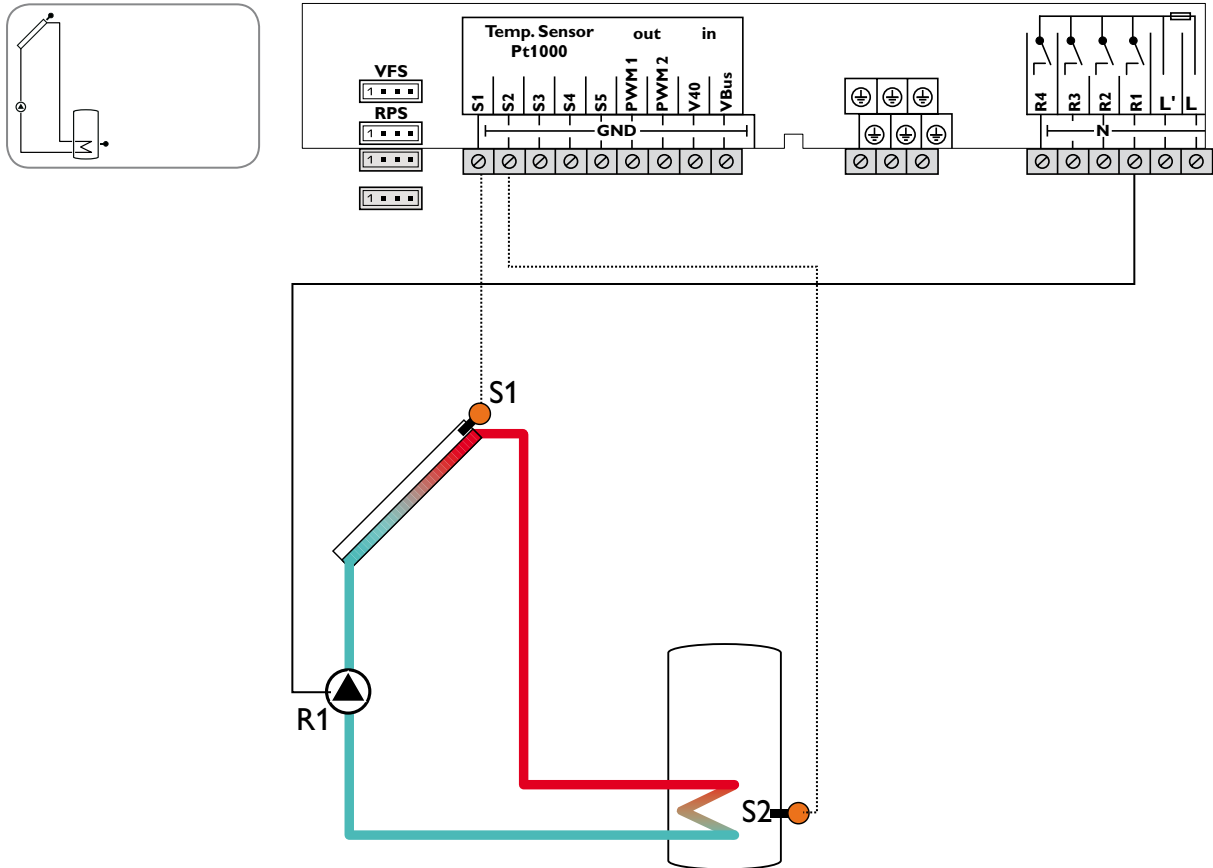

Sensor/Terminal	Designation	Description
S1	TCOL	Temperature collector
S2	TSTB	Temperature tank bottom
S3		Optional sensor for measurement purposes or options
S4		
S5		
VFS		
RPS		
V40		

Relay	Description
R1	Solar pump
R2	optional:
R3	Thermal disinfection
R4	Booster pump
	Parallel relay
	Heat dump

Adjustment channels						
Channel	Sub channel 1	Sub channel 2	Factory setting	Change to	Description	Page
ARR			1		System	78
LOAD >					Loading	
	DT O		12 °R		Switch-on temperature difference	78
	DT F		8 °R		Switch-off temperature difference	78
	DT S		20 °R		Set temperature difference	78
	RIS		4 °R		Rise	78
	S MAX		140 °F		Tank maximum limitation	78
	S MAXS		2		Sensor tank max	79
COL >					Collector	
	CEM		270 °F		Collector emergency temperature	80
	OCCO**		OFF		Option collector cooling	80
		C MAX	230 °F		Maximum collector temperature	80
	O CMI		OFF		Option collector minimum limitation	80
		C MIN	50 °F		Minimum collector temperature	80

Adjustment channels						
Channel	Sub channel 1	Sub channel 2	Factory setting	Change to	Description	Page
	OTCO		OFF		Option evacuated tube collector function	81
		TCST	07:00		Evacuated tube collector starting time	81
		TCEN	19:00		Evacuated tube collector ending time	81
		TCRU	30 s		Evacuated tube collector runtime	81
		TCIN	30 min		Evacuated tube collector standstill interval	81
	OCFR		OFF		Option collector frost protection	82
		CFR O	40 °F		Antifreeze temperature collector on	82
		CFR F	42 °F		Antifreeze temperature collector off	82
LLOGI >					Loading logic	
	ODB >		OFF		Drainback option	84
	OOVRU*		OFF		Overrun option	84
COOL >					Cooling functions	
	OSYC**		OFF		System cooling	85
	OSTC		OFF		Tank cooling	85
	OHDP**		OFF		Heat dump	85
PUMP >					Pump speed	
	PUMP1		OnOF		Speed variant pump 1	79
	PUMP2		OnOF		Speed variant pump 2	79
	PUMP3		OnOF		Speed variant pump 3	79
MAN >					Manual mode	
	MAN1		Auto		Manual mode 1	88
	MAN2		Auto		Manual mode 2	88
	MAN3		Auto		Manual mode 3	88
	MAN4		Auto		Manual mode 4	88
BLPR >			OFF		Blocking protection	88
OTDIS >			OFF		Thermal disinfection option	89
OPARR >			OFF		Parallel relay option	90
OHQM >			OFF		Energy metering option	90
GFDS >			OFF		Registration Grundfos sensors	90
PRS* >			OFF		Pressure monitoring option	92
DATE >			OFF		Enter date	92
LANG >			En		Language	93
UNIT >			°F		Unit	92
OSDC >					SD card option	93
CODE			0000		User code	96
RESET			OFF		Factory setting	

* This channel is only available if the Grundfos sensors have been registered in the **GFDS** channel.

** are blocked against each other

System 2

Solar system with 2 tanks and heat exchange

The controller calculates the temperature difference between collector sensor S1 and tank sensor S2. If the difference is larger than or identical to the adjusted switch-on temperature difference, the pump (R1) will be switched on

and the tank will be loaded until the switch-off temperature difference or the maximum tank temperature is reached. Heat exchange between S3 and S4 is possible.

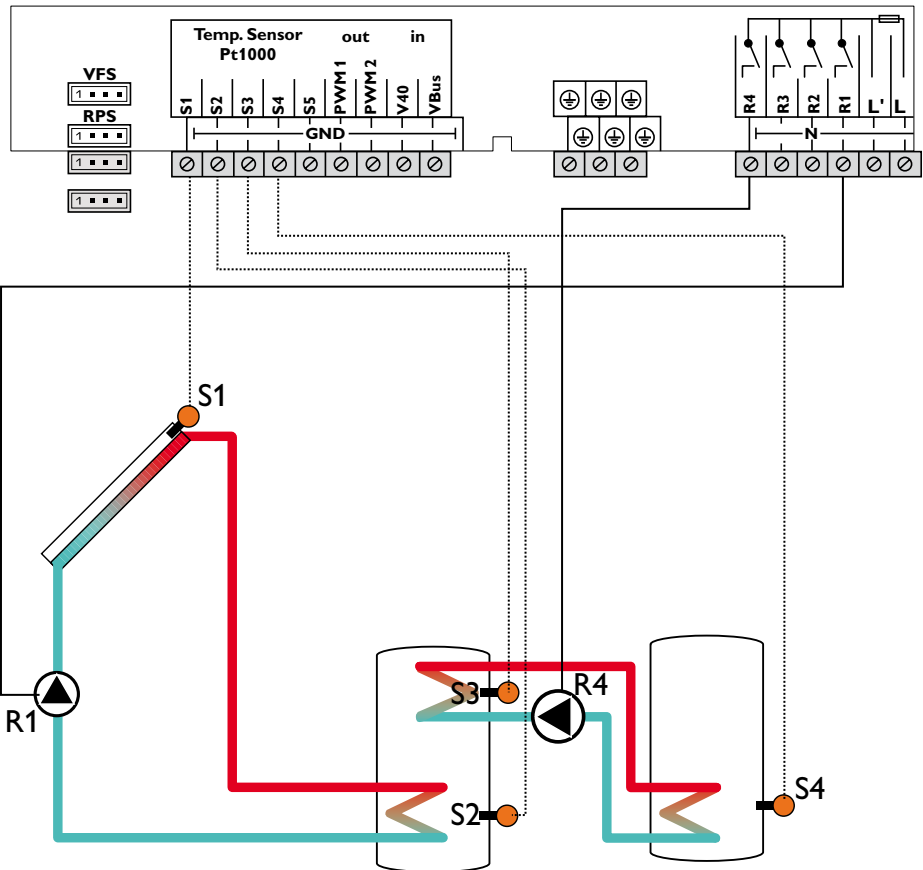
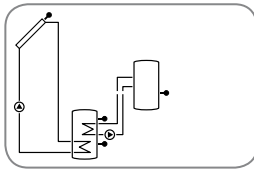

Sensor/Terminal	Designation	Description
S1	TCOL	Temperature collector
S2	TST1B	Temperature tank 1 bottom
S3	TST1T	Temperature tank 1 top
S4	TST2B	Temperature tank 2 top
S5		Optional sensor for measurement purposes or options
VFS		
RPS		
V40		

Relay	Description
R1	Solar pump
R2	Heat exchange pump
R3	optional:
R4	Thermal disinfection Booster pump Parallel relay Heat dump

Adjustment channels						
Channel	Sub channel 1	Sub channel 2	Factory setting	Change to	Description	Page
ARR			1	2	System	78
LOAD >					Loading	
	DT O		12 °R		Switch-on temperature difference	78
	DT F		8 °R		Switch-off temperature difference	78
	DT S		20 °R		Set temperature difference	78
	RIS		4 °R		Rise	78
	S MAX		140 °F		Tank maximum limitation	79
	S MAXS		2		Sensor tank max	79
COL >					Collector	
	CEM		270 °F		Collector emergency temperature	80
	OCCO**		OFF		Option collector cooling	80
		C MAX	230 °F		Maximum collector temperature	80
	O CMI		OFF		Option collector minimum limitation	80
		C MIN	50 °F		Minimum collector temperature	80

Adjustment channels						
Channel	Sub channel 1	Sub channel 2	Factory setting	Change to	Description	Page
	OTCO		OFF		Option evacuated tube collector function	81
		TCST	07:00		Evacuated tube collector starting time	81
		TCEN	19:00		Evacuated tube collector ending time	81
		TCRU	30 s		Evacuated tube collector runtime	81
		TCIN	30 min		Evacuated tube collector standstill interval	81
	OCFR		OFF		Option collector frost protection	82
		CFR O	40 °F		Antifreeze temperature collector on	82
		CFR F	42 °F		Antifreeze temperature collector off	82
LLOGI >					Loading logic	
	ODB >		OFF		Drainback option	84
	OOVRU*		OFF		Overrun option	84
COOL >					Cooling functions	
	OSYC**		OFF		System cooling	85
	OSTC		OFF		Tank cooling	85
	OHDP**		OFF		Heat dump	85
DT3 >					Heat exchange	
	DT3O		12 °R		Switch-on difference	86
	DT3F		8 °R		Switch-off difference	86
	DT3S		20 °R		Set difference	86
	RIS3		4 °R		Rise	86
	MAX3O		140 °F		Switch-on temperature (maximum limitation)	86
	MAX3F		136 °F		Switch-off temperature (maximum limitation)	86
	MIN3O		40 °F		Switch-on temperature (minimum limitation)	86
	MIN3F		50 °F		Switch-off temperature (minimum limitation)	86
	S2DT3		4		Reference sensor heat sink	86
PUMP >					Pump speed	
	PUMP1		OnOF		Speed variant pump 1	79
	PUMP2		OnOF		Speed variant pump 2	79
	PUMP3		OnOF		Speed variant pump 3	79
MAN >					Manual mode	
	MAN1		Auto		Manual mode 1	88
	MAN2		Auto		Manual mode 2	88
	MAN3		Auto		Manual mode 3	88
	MAN4		Auto		Manual mode 4	88
BLPR >			OFF		Blocking protection	88
OTDIS >			OFF		Thermal disinfection option	89
OPARR >			OFF		Parallel relay option	90
OHQM >			OFF		Energy metering option	90
GFDS >			OFF		Registration Grundfos sensors	90
PRS* >			OFF		Pressure monitoring option	92
DATE >			OFF		Enter date	92
LANG >			En		Language	93
UNIT >			°F		Unit	92
OSDC >					SD card option	93
CODE			0000		User code	96
RESET			OFF		Factory setting	

* This channel is only available if the Grundfos sensors have been registered in the **GFDS** channel.

** are blocked against each other

System 3

Solar system with 1 tank and backup heating

The controller calculates the temperature difference between collector sensor S1 and tank sensor S2. If the difference is larger than or identical to the adjusted switch-on temperature difference, the pump (R1) will be switched on and the tank will be loaded until the switch-off temperature difference or the maximum tank temperature is reached.

Domestic hot water backup heating (R4) can be carried out with a thermostat function (S3). If the value at S3 reaches the switch-on temperature for the backup heating, the relay is energized. If the value exceeds the switch-off temperature for the backup heating, the relay is switched off again.

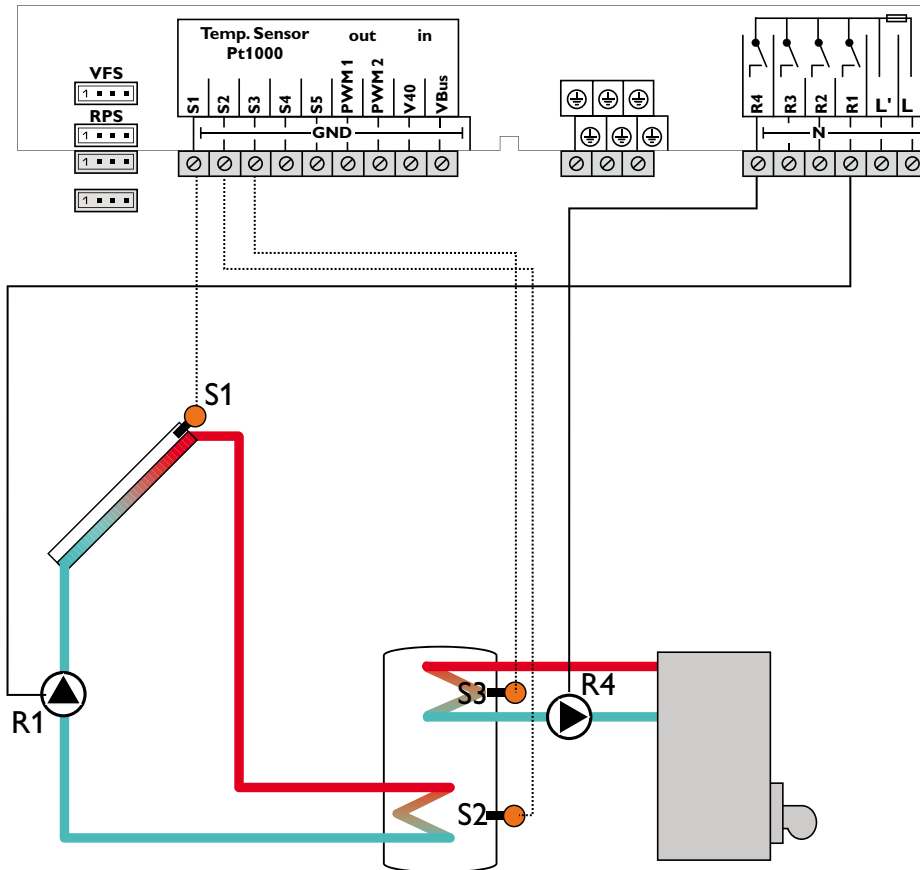

Sensor/Terminal	Designation	Description
S1	TCOL	Temperature collector
S2	TSTB	Temperature tank bottom
S3	TSTT	Temperature tank top
S4		Optional sensor for measurement purposes or options
S5		
VFS		
RPS		
V40		

Relay	Description
R1	Solar pump
R2	optional:
R3	Thermal disinfection Booster pump Parallel relay Heat dump
R4	Backup heating/tank loading pump

Adjustment channels						
Channel	Sub channel 1	Sub channel 2	Factory setting	Change to	Description	Page
ARR			1	3	System	78
LOAD >					Loading	
	DT O		12 °R		Switch-on temperature difference	78
	DT F		8 °R		Switch-off temperature difference	78
	DT S		20 °R		Set temperature difference	78
	RIS		4 °R		Rise	78
	S MAX		140 °F		Tank maximum limitation	79
	S MAXS		2		Sensor tank max	79
COL >					Collector	
	CEM		270 °F		Collector emergency temperature	80
	OCCO**		OFF		Option collector cooling	80

Adjustment channels						
Channel	Sub channel 1	Sub channel 2	Factory setting	Change to	Description	Page
		CMAX	230 °F		Maximum collector temperature	80
	OCCI		OFF		Option collector minimum limitation	80
		CMIN	50 °F		Minimum collector temperature	80
	OTCO		OFF		Option evacuated tube collector function	81
		TCST	07:00		Evacuated tube collector starting time	81
		TCEN	19:00		Evacuated tube collector ending time	81
		TCRU	30 s		Evacuated tube collector runtime	81
		TCIN	30 min		Evacuated tube collector standstill interval	81
	OCFR		OFF		Option collector frost protection	82
		CFR O	40 °F		Antifreeze temperature collector on	82
		CFR F	42 °F		Antifreeze temperature collector off	82
LLOGI >					Loading logic	
	ODB >		OFF		Drainback option	84
	OOVRU*		OFF		Overrun option	84
COOL >					Cooling functions	
	OSYC**		OFF		System cooling	85
	OSTC		OFF		Tank cooling	85
	OHDP**		OFF		Heat dump	85
AH >					Backup heating option	
	AH O		110 °F		Backup heating switch-on temperature	87
	AH F		120 °F		Backup heating switch-off temperature	87
	t1O		06:00		Switch-on time 1	88
	t1F		22:00		Switch-off time 1	88
	t2O		00:00		Switch-on time 2	88
	t2F		00:00		Switch-off time 2	88
	t3O		00:00		Switch-on time 3	88
	t3F		00:00		Switch-off time 3	88
PUMP >					Pump speed	
	PUMP1		OnOF		Speed variant pump 1	79
	PUMP2		OnOF		Speed variant pump 2	79
	PUMP3		OnOF		Speed variant pump 3	79
MAN >					Manual mode	
	MAN1		Auto		Manual mode 1	88
	MAN2		Auto		Manual mode 2	88
	MAN3		Auto		Manual mode 3	88
	MAN4		Auto		Manual mode 4	88
BLPR >			OFF		Blocking protection	88
OTDIS >			OFF		Thermal disinfection option	89
OPARR >			OFF		Parallel relay option	90
OHQM >			OFF		Energy metering option	90
GFDS >			OFF		Registration Grundfos sensors	90
PRS* >			OFF		Pressure monitoring option	92
DATE >					Enter date	92
LANG >			En		Language	93
UNIT >			°F		Unit	92
OSDC >					SD card option	93
CODE			0000		User code	96
RESET			OFF		Factory setting	

* This channel is only available if the Grundfos sensors have been registered in the **GFDS** channel.

** are blocked against each other

System 4

Solar system with 1 tank and 3-port valve for vertical tank loading

The controller compares the temperature at sensor S1 to the temperatures at sensors S2 and S3. If the measured temperature differences are higher than the adjusted switch-on temperature differences, the pump (R1) will be activated

and the corresponding tank zone will be loaded up to the adjusted maximum temperature via the valve (R3). The priority logic effects prior loading of the upper zone of the tank.

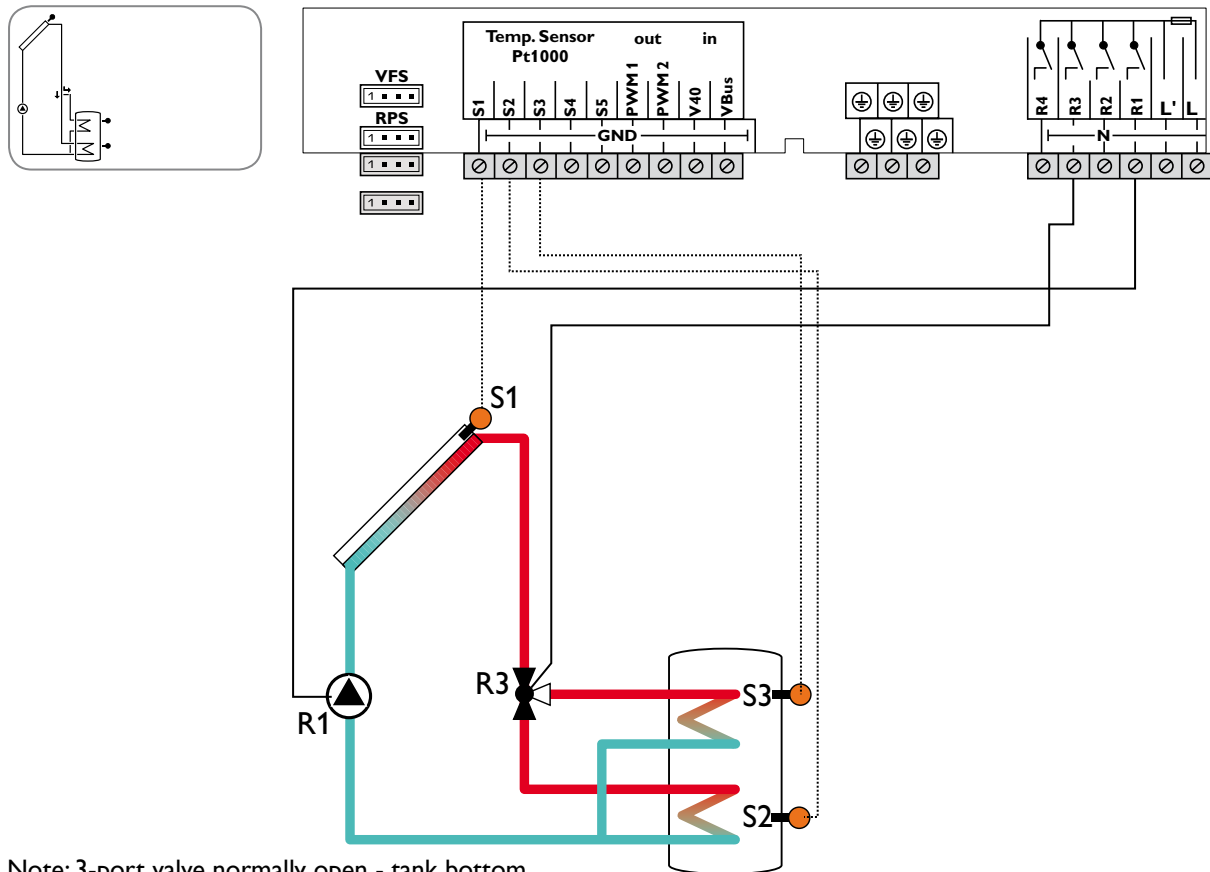

Note: 3-port valve normally open - tank bottom

Sensor/Terminal	Designation	Description
S1	TCOL	Temperature collector
S2	TSTB	Temperature tank bottom
S3	TSTT	Temperature tank top
S4		Optional sensor for measurement purposes or options
S5		
VFS		
RPS		
V40		

Relay	Description
R1	Solar pump
R2/R4	optional: Thermal disinfection Parallel relay Heat dump
R3	3-port valve tank top/bottom

Adjustment channels						
Channel	Sub channel 1	Sub channel 2	Factory setting	Change to	Description	Page
ARR			1	4	System	78
LOAD1 >					Loading 1	
	DT1O		12 °R		Switch-on temperature difference 1	78
	DT1F		8 °R		Switch-off temperature difference 1	78
	DT1S		20 °R		Set temperature difference 1	78
	RIS1		4 °R		Rise 1	78
	S1MAX		140 °F		Tank maximum limitation 1	78
	SMXS1		2		Sensor tank max 1	79
LOAD2 >					Loading 2	
	DT2O		12 °R		Switch-on temperature difference 2	78
	DT2F		8 °R		Switch-off temperature difference 2	78
	DT2S		20 °R		Set temperature difference 2	78
	RIS2		4 °R		Rise 2	78
	S2MAX		140 °F		Tank maximum limitation 2	78

Adjustment channels						
Channel	Sub channel 1	Sub channel 2	Factory setting	Change to	Description	Page
	LST2		ON		Loading tank 2	79
COL >					Collector	
	CEM		270 °F		Collector emergency temperature	80
	OCCO**		OFF		Option collector cooling	80
		CMAX	230 °F		Maximum collector temperature	80
	OCCI		OFF		Option collector minimum limitation	80
		CMIN	50 °F		Minimum collector temperature	80
	OTCO		OFF		Option evacuated tube collector function	81
		TCST	07:00		Evacuated tube collector starting time	81
		TCEN	19:00		Evacuated tube collector ending time	81
		TCRU	30 s		Evacuated tube collector runtime	81
		TCIN	30 min		Evacuated tube collector standstill interval	81
	O CFR		OFF		Option collector frost protection	82
		CFR O	40 °F		Antifreeze temperature collector on	82
		CFR F	42 °F		Antifreeze temperature collector off	82
LLOGI >					Loading logic	
	PRIO				Priority logic	82
		PRIO	2		Priority logic	82
		OSTS	OFF		Tank set option	83
		TST1	120 °F		Set tank temperature tank 1	83
		TST2	120 °F		Set tank temperature tank 2	83
	tLB		2 min		Loading break time	82
	tRUN		15 min		Circulation runtime	82
	PSPEE		OFF		Pause speed option	83
	PDELA		OFF		Pump delay option	83
	OOVRU*		OFF		Overrun option	84
COOL >					Cooling functions	
	OSYC**		OFF		System cooling	85
	OSTC		OFF		Tank cooling	85
	OHDP**		OFF		Heat dump	85
PUMP >					Pump speed	
	PUMP1		OnOF		Speed variant pump 1	79
	PUMP2		OnOF		Speed variant pump 2	79
	PUMP3		OnOF		Speed variant pump 3	79
MAN >					Manual mode	
	MAN1		Auto		Manual mode 1	88
	MAN2		Auto		Manual mode 2	88
	MAN3		Auto		Manual mode 3	88
	MAN4		Auto		Manual mode 4	88
BLPR >			OFF		Blocking protection	88
OTDIS >			OFF		Thermal disinfection option	89
OPARR >			OFF		Parallel relay option	90
OHQM >			OFF		Energy metering option	90
GFDS >			OFF		Registration Grundfos sensors	90
PRS* >			OFF		Pressure monitoring option	92
DATE >			OFF		Enter date	92
LANG >			En		Language	93
UNIT >			°F		Unit	92
OSDC >					SD card option	93
CODE			0000		User code	96
RESET			OFF		Factory setting	

* This channel is only available if the Grundfos sensors have been registered in the **GFDS** channel.

** are blocked against each other

System 5

2-tank system with valve logic, 1 pump, 3 sensors and 3-port valve

The controller compares the temperature at sensor S1 to the temperatures at sensors S2 and S4. If the measured temperature differences are higher than the adjusted switch-on temperature differences, the pump (R1) will be activated and

the corresponding tank will be loaded up to the adjusted maximum temperature via the valve (R3). Tank 1 is loaded with priority.

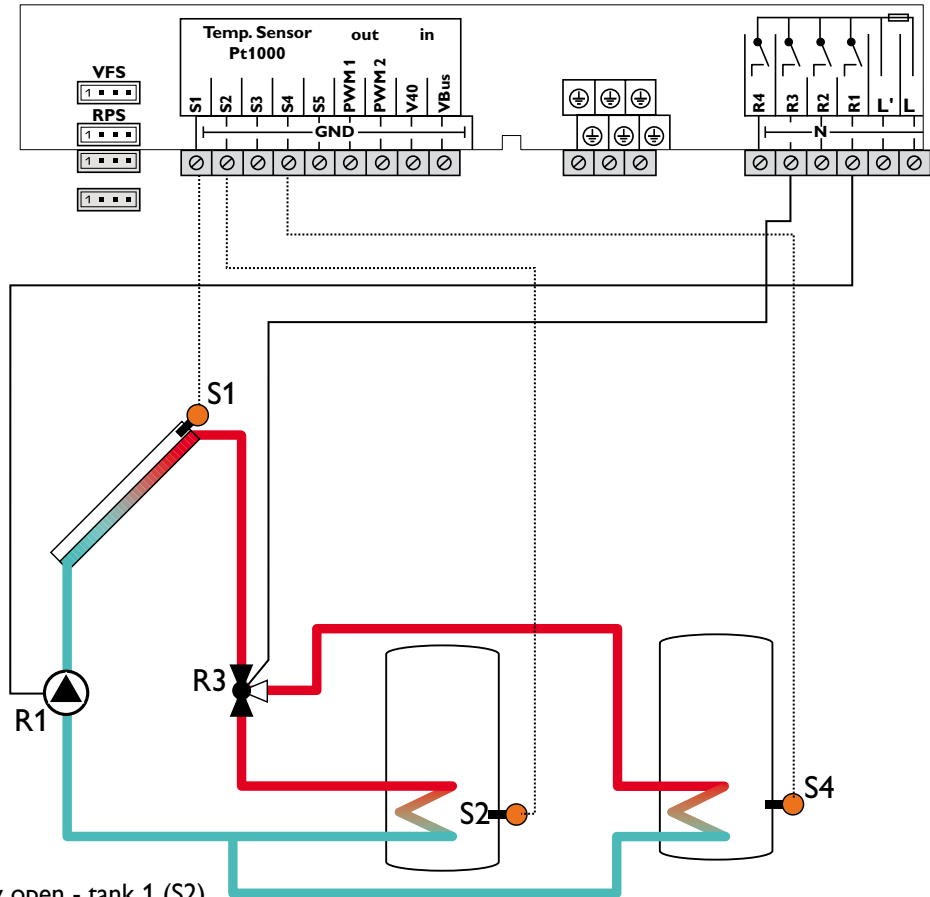
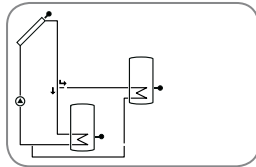

Note: 3-port valve normally open - tank 1 (S2)

Sensor/Terminal	Designation	Description
S1	TCOL	Temperature collector
S2	TST1B	Temperature tank 1 bottom
S3		Optional sensor for measurement purposes or options
S4	TST2B	Temperature tank 2 bottom
S5		Optional sensor for measurement purposes or options
VFS		
RPS		
V40		

Relay	Description
R1	Solar pump
R2/R4	optional: Thermal disinfection Parallel relay Heat dump
R3	3-port valve tank 1 / 2

Adjustment channels						
Channel	Sub channel 1	Sub channel 2	Factory setting	Change to	Description	Page
ARR			1	5	System	78
LOAD1 >					Loading 1	
	DT1O		12 °R		Switch-on temperature difference 1	78
	DT1F		8 °R		Switch-off temperature difference 1	78
	DT1S		20 °R		Set temperature difference 1	78
	RIS1		4 °R		Rise 1	78
	S1MAX		140 °F		Tank maximum limitation 1	78
	SMXS1		2		Sensor tank max 1	79
LOAD2 >					Loading 2	
	DT2O		12 °R		Switch-on temperature difference 2	78
	DT2F		8 °R		Switch-off temperature difference 2	78

Adjustment channels						
Channel	Sub channel 1	Sub channel 2	Factory setting	Change to	Description	Page
	DT2S		20 °R		Set temperature difference 2	78
	RIS2		4 °R		Rise 2	78
	S2MAX		140 °F		Tank maximum limitation 2	78
	SMXS2		4		Sensor tank max 2	79
	LST2		ON		Loading tank 2	79
COL >					Collector	
	CEM		270 °F		Collector emergency temperature	80
	OCCO**		OFF		Option collector cooling	80
		CMAX	230 °F		Maximum collector temperature	80
	OCCI		OFF		Option collector minimum limitation	80
		CMIN	50 °F		Minimum collector temperature	80
	OTCO		OFF		Option evacuated tube collector function	81
		TCST	07:00		Evacuated tube collector starting time	81
		TCEN	19:00		Evacuated tube collector ending time	81
		TCRU	30 s		Evacuated tube collector runtime	81
		TCIN	30 min		Evacuated tube collector standstill interval	81
	O CFR		OFF		Option collector frost protection	82
		CFR O	40 °F		Antifreeze temperature collector on	82
		CFR F	42 °F		Antifreeze temperature collector off	82
		FRPST	1		Antifreeze tank selection	82
LLOGI >					Loading logic	
	PRIO				Priority logic	82
		PRIO	1		Priority logic	82
		OSTS	OFF		Tank set option	83
		TST1	120 °F		Set tank temperature tank 1	83
		TST2	120 °F		Set tank temperature tank 2	83
	tLB		2 min		Loading break time	82
	tRUN		15 min		Circulation runtime	82
	PSPEE		OFF		Pause speed option	83
	PDELA		OFF		Pump delay option	83
	OOVRU*		OFF		Overrun option	84
COOL >					Cooling functions	
	OSYC**		OFF		System cooling	85
	O STC		OFF		Tank cooling	85
	OHDP**		OFF		Heat dump	85
PUMP >					Pump speed	
	PUMP1		OnOF		Speed variant pump 1	79
	PUMP2		OnOF		Speed variant pump 2	79
	PUMP3		OnOF		Speed variant pump 3	79
MAN >					Manual mode	
	MAN1		Auto		Manual mode 1	88
	MAN2		Auto		Manual mode 2	88
	MAN3		Auto		Manual mode 3	88
	MAN4		Auto		Manual mode 4	88
BLPR >			OFF		Blocking protection	88
OTDIS >			OFF		Thermal disinfection option	89
OPARR >			OFF		Parallel relay option	90
OHQM >			OFF		Energy metering option	90
GFDS >			OFF		Registration Grundfos sensors	90
PRS* >			OFF		Pressure monitoring option	92
DATE >					Enter date	92
LANG >			En		Language	93
UNIT >			°F		Unit	92
OSDC >					SD card option	93
CODE			0000		User code	96
RESET			OFF		Factory setting	

* This channel is only available if the Grundfos sensors have been registered in the **GFDS** channel.

** are blocked against each other

System 6

2-tank solar system with pump logic

The controller compares the temperature at sensor S1 to the temperatures at sensors S2 and S4. If the measured temperature differences are higher than the adjusted switch-on temperature differences, the pump (R1 and R2) will be

activated and the corresponding tank will be loaded up to the adjusted maximum temperature at most.

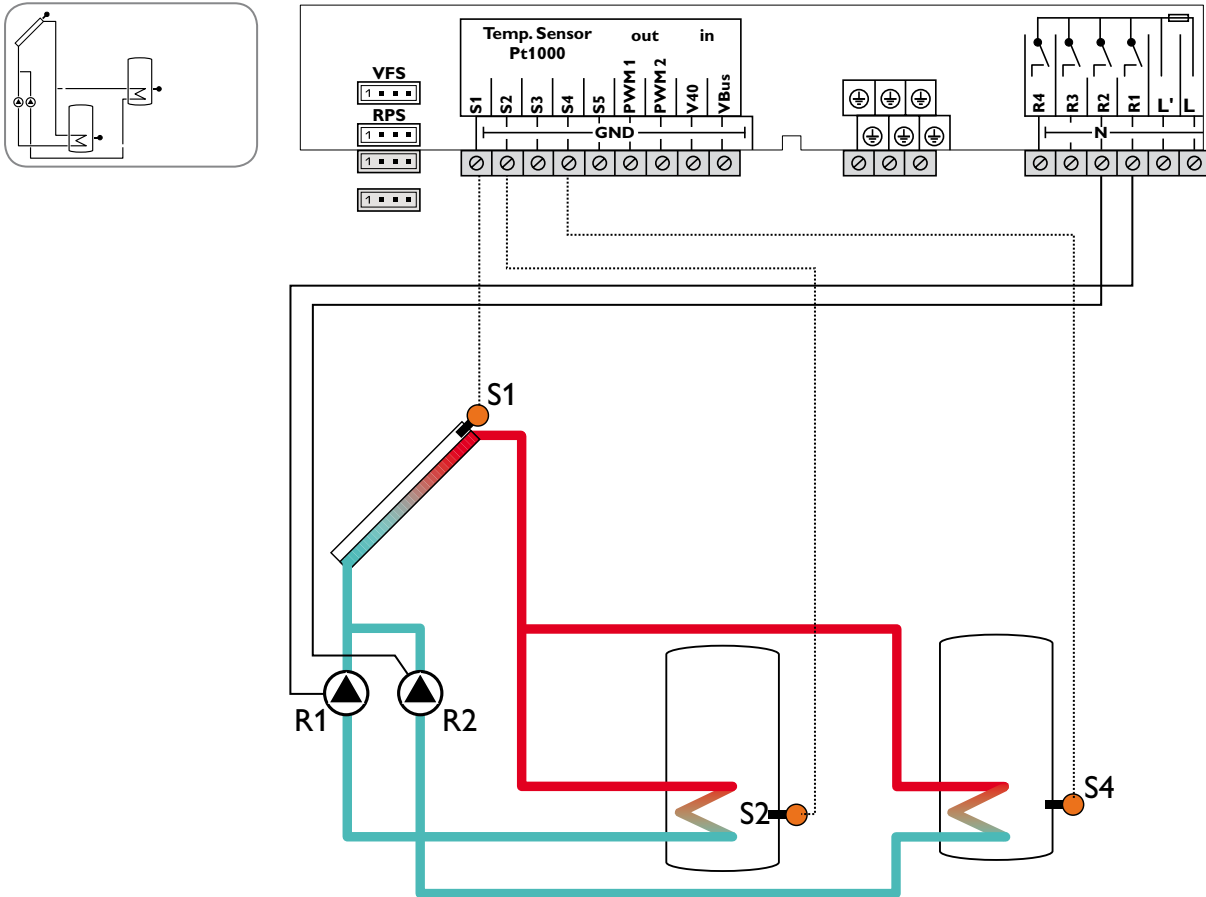

Sensor/Terminal	Designation	Description
S1	TCOL	Temperature collector
S2	TST1B	Temperature tank 1 bottom
S3		Optional sensor for measurement purposes or options
S4	TST2B	Temperature tank 2 bottom
S5		Optional sensor for measurement purposes or options
VFS		
RPS		
V40		

Relay	Description
R1	Solar pump tank 1
R2	Solar pump tank 2
R3	optional:
R4	Thermal disinfection Parallel relay Heat dump

Adjustment channels						
Channel	Sub channel 1	Sub channel 2	Factory setting	Change to	Description	Page
ARR			1	6	System	78
LOAD1 >					Loading 1	
	DT1O		12 °R		Switch-on temperature difference 1	78
	DT1F		8 °R		Switch-off temperature difference 1	78
	DT1S		20 °R		Set temperature difference 1	78
	RIS1		4 °R		Rise 1	78
	S1MAX		140 °F		Tank maximum limitation 1	78
	SMXS1		2		Sensor tank max 1	79
LOAD2 >					Loading 2	
	DT2O		12 °R		Switch-on temperature difference 2	78
	DT2F		8 °R		Switch-off temperature difference 2	78
	DT2S		20 °R		Set temperature difference 2	78
	RIS2		4 °R		Rise 2	78

Adjustment channels						
Channel	Sub channel 1	Sub channel 2	Factory setting	Change to	Description	Page
	S2MAX		140 °F		Tank maximum limitation 2	78
	SMXS2		4		Sensor tank max 2	79
	LST2		ON		Loading tank 2	79
COL >					Collector	
	CEM		270 °F		Collector emergency temperature	80
	OCCO**		OFF		Option collector cooling	80
		CMAX	230 °F		Maximum collector temperature	80
	OCCI		OFF		Option collector minimum limitation	80
		CMIN	50 °F		Minimum collector temperature	80
	OTCO		OFF		Option evacuated tube collector function	81
		TCST	07:00		Evacuated tube collector starting time	81
		TCEN	19:00		Evacuated tube collector ending time	81
		TCRU	30 s		Evacuated tube collector runtime	81
		TCIN	30 min		Evacuated tube collector standstill interval	81
	O CFR		OFF		Option collector frost protection	82
		CFR O	40 °F		Antifreeze temperature collector on	82
		CFR F	42 °F		Antifreeze temperature collector off	82
		FRPST	1		Antifreeze tank selection	82
LLOGI >					Loading logic	
	PRIO				Priority logic	82
		PRIO	1		Priority logic	82
		OSTS	OFF		Tank set option	83
		TST1	120 °F		Set tank temperature tank 1	83
		TST2	120 °F		Set tank temperature tank 2	83
		OSE	OFF		Spread function option	83
		DTSE	40		Spread difference	83
	tLB		2 min		Loading break time	82
	tRUN		15 min		Circulation runtime	82
	PSPEE		OFF		Pause speed option	83
	PDELA		OFF		Pump delay option	83
	OVRU*		OFF		Overrun option	84
COOL >					Cooling functions	
	OSYC**		OFF		System cooling	85
	OSTC		OFF		Tank cooling	85
	OHDP**		OFF		Heat dump	85
PUMP >					Pump speed	
	PUMP1		OnOF		Speed variant pump 1	79
	PUMP2		OnOF		Speed variant pump 2	79
	PUMP3		OnOF		Speed variant pump 3	79
MAN >					Manual mode	
	MAN1		Auto		Manual mode 1	88
	MAN2		Auto		Manual mode 2	88
	MAN3		Auto		Manual mode 3	88
	MAN4		Auto		Manual mode 4	88
BLPR >			OFF		Blocking protection	88
OTDIS >			OFF		Thermal disinfection option	89
OPARR >			OFF		Parallel relay option	90
OHQM >			OFF		Energy metering option	90
GFDS >			OFF		Registration Grundfos sensors	90
PRS* >			OFF		Pressure monitoring option	92
DATE >					Enter date	92
LANG >			En		Language	93
UNIT >			°F		Unit	92
OSDC >					SD card option	93
CODE			0000		User code	96
RESET			OFF		Factory setting	

* This channel is only available if the Grundfos sensors have been registered in the **GFDS** channel.

** are blocked against each other

System 7

Solar system with east-/west collectors

The controller compares the temperatures at the collector sensors S1 and S5 to the tank temperature at sensor S2. If one of the measured temperature differences is higher

than the adjusted switch-on temperature differences, the corresponding pump (R1, R2) will be activated and the tank will be loaded.

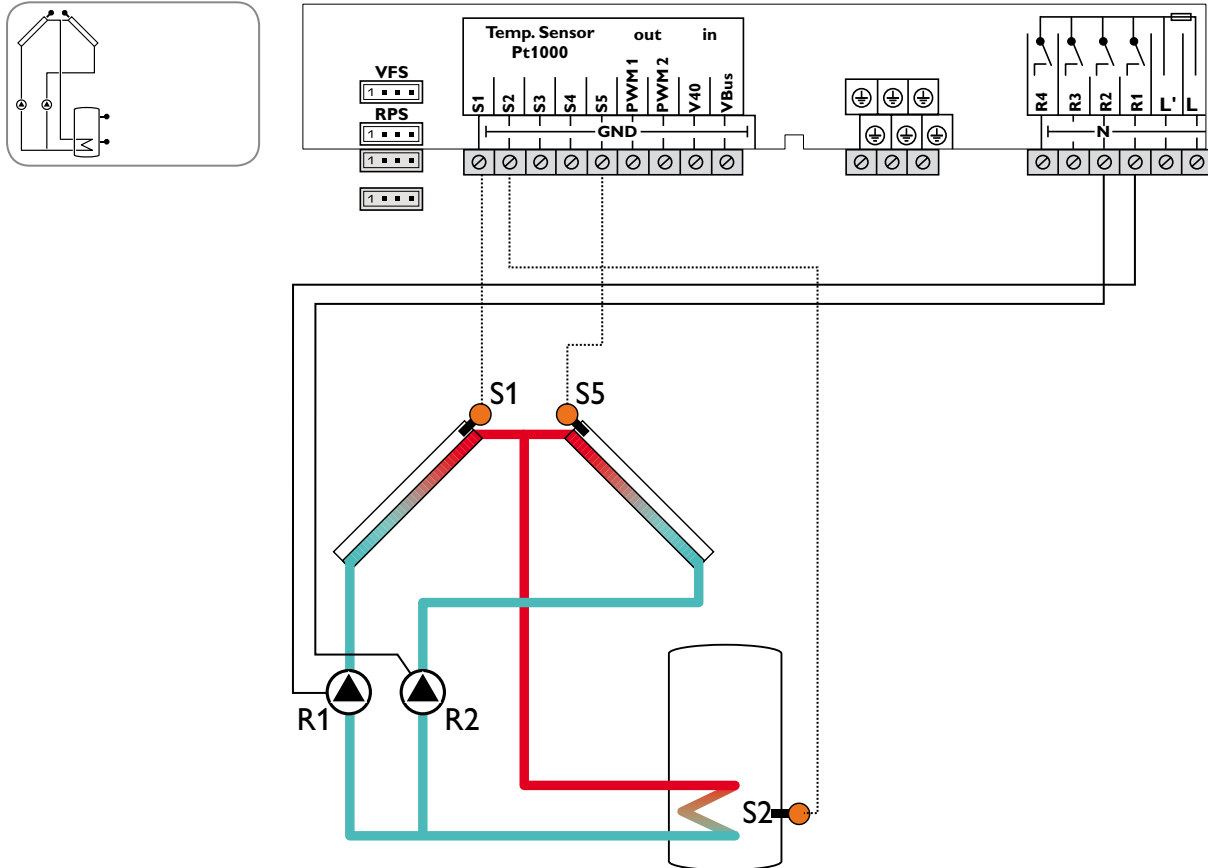

Sensor/Terminal	Designation	Description
S1	TCOL1	Temperature collector 1
S2	TSTB	Temperature tank bottom
S3		Optional sensor for measurement purposes or options
S4		Optional sensor for measurement purposes or options
S5	TCOL2	Temperature collector 2
VFS		Optional sensor for measurement purposes or options
RPS		Optional sensor for measurement purposes or options
V40		

Adjustment channels						
Channel	Sub channel 1	Sub channel 2	Factory setting	Change to	Description	Page
ARR			1	7	System Loading	78
LOAD >						
	DT O		12 °R		Switch-on temperature difference	78
	DT F		8 °R		Switch-off temperature difference	78
	DT1S		20 °R		Set temperature difference	78
	RIS		4 °R		Rise	78
	S MAX		140 °F		Tank maximum limitation	78
	S MAXS		2		Sensor tank max	79
COL 1 >					Collector 1	
	CEM1		270 °F		Collector emergency temperature 1	80
	OCCO1**		OFF		Option collector cooling 1	80
		C MAX1	230 °F		Maximum collector temperature 1	80
	OCMI1		OFF		Option collector minimum limitation 1	80
		C MIN1	50 °F		Minimum collector temperature 1	80
	OTCO1		OFF		Option evacuated tube collector function 1	81

Adjustment channels						
Channel	Sub channel 1	Sub channel 2	Factory setting	Change to	Description	Page
		TCST1	07:00		Evacuated tube collector starting time 1	81
		TCEN1	19:00		Evacuated tube collector ending time 1	81
		TCRU1	30 s		Evacuated tube collector runtime 1	81
		TCIN1	30 min		Evacuated tube collector standstill interval 1	81
	OCFR		OFF		Option collector frost protection	82
		CFR O	40 °F		Antifreeze temperature collector on	82
		CFR F	42 °F		Antifreeze temperature collector off	82
COL 2 >					Collector 2	
	CEM2		270 °F		Collector emergency temperature 2	80
	OCCO2**		OFF		Option collector cooling 2	80
		CMAX2	230 °F		Maximum collector temperature 2	80
	OCSI2		OFF		Option collector minimum limitation 2	80
		CMIN2	50 °F		Minimum collector temperature 2	80
	OTCO2		OFF		Option evacuated tube collector function 2	81
		TCST2	07:00		Evacuated tube collector starting time 2	81
		TCEN2	19:00		Evacuated tube collector ending time 2	81
		TCRU2	30 s		Evacuated tube collector runtime 2	81
		TCIN2	30 min		Evacuated tube collector standstill interval 2	81
LLOGI >					Loading logic	
	OOVRU*		OFF		Overrun option	84
COOL >					Cooling functions	
	OSYC**		OFF		System cooling	85
	OSTC		OFF		Tank cooling	85
	OHDP**		OFF		Heat dump	85
PUMP >					Pump speed	
	PUMP1		OnOF		Speed variant pump 1	79
	PUMP2		OnOF		Speed variant pump 2	79
	PUMP3		OnOF		Speed variant pump 3	79
MAN >					Manual mode	
	MAN1		Auto		Manual mode 1	88
	MAN2		Auto		Manual mode 2	88
	MAN3		Auto		Manual mode 3	88
	MAN4		Auto		Manual mode 4	88
BLPR >			OFF		Blocking protection	88
OTDIS >			OFF		Thermal disinfection option	89
OPARR >			OFF		Parallel relay option	90
OHQM >			OFF		Energy metering option	90
GFDS >			OFF		Registration Grundfos sensors	90
PRS* >			OFF		Pressure monitoring option	92
DATE >					Enter date	92
LANG >			En		Language	93
UNIT >			°F		Unit	92
OSDC >					SD card option	93
CODE			0000		User code	96
RESET			OFF		Factory setting	

* This channel is only available if the Grundfos sensors have been registered in the **GFDS** channel.

** are blocked against each other

System 8

Solar system with 1 tank and backup heating with solid fuel boiler

The controller calculates the temperature difference between collector sensor S1 and tank sensor S2. If the difference is larger than or identical to the adjusted switch-on temperature difference, the pump (R1) will be switched on and the tank will be loaded until the switch-off temperature

difference or the maximum tank temperature is reached. With another temperature differential function (S4/S3), backup heating of the tank can be carried out with a solid fuel boiler (R3).

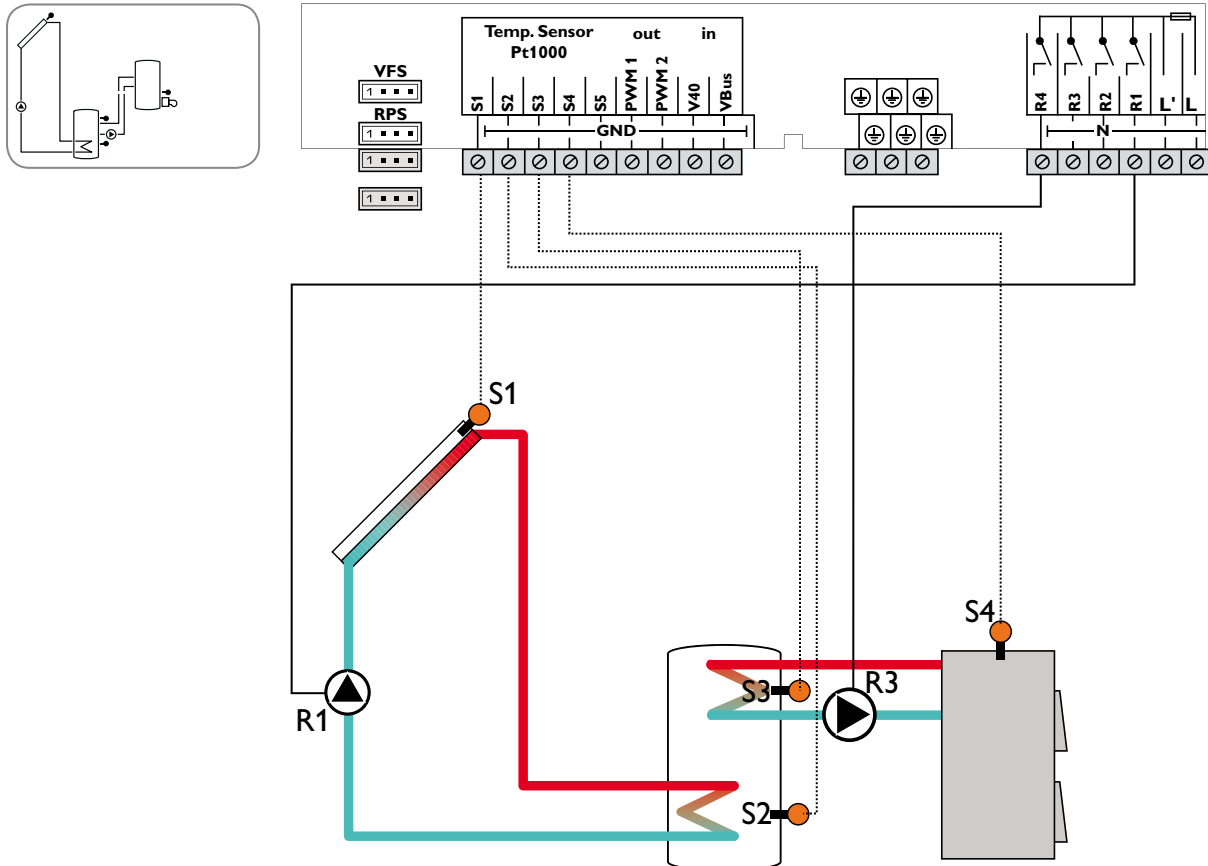

Sensor/Terminal	Designation	Description
S1	TCOL	Temperature collector
S2	TSTB	Temperature tank bottom
S3	TSTT	Temperature tank top
S4	TSFB	Temperature solid fuel boiler
S5		Optional sensor for measurement purposes or options
VFS		
RPS		
V40		

Relay	Description
R1	Solar pump
R3	Loading pump solid fuel boiler
R2	optional:
R4	Thermal disinfection Booster pump Parallel relay Heat dump

Adjustment channels						
Channel	Sub channel 1	Sub channel 2	Factory setting	Change to	Description	Page
ARR			1	8	System	78
LOAD >					Loading	
	DT O		12 °R		Switch-on temperature difference	78
	DT F		8 °R		Switch-off temperature difference	78
	DT S		20 °R		Set temperature difference	78
	RIS		4 °R		Rise	78
	S MAX		140 °F		Tank maximum limitation	78
	SMAXS		2		Sensor tank max	79
COL >					Collector	
	CEM		270 °F		Collector emergency temperature	80
	OCCO**		OFF		Option collector cooling	80
		C MAX	230 °F		Maximum collector temperature	80
	O CMI		OFF		Option collector minimum limitation	80

Adjustment channels						
Channel	Sub channel 1	Sub channel 2	Factory setting	Change to	Description	Page
		CMIN	50 °F		Minimum collector temperature	80
	OTCO		OFF		Option evacuated tube collector function	81
		TCST	07:00		Evacuated tube collector starting time	81
		TCEN	19:00		Evacuated tube collector ending time	81
		TCRU	30 s		Evacuated tube collector runtime	81
		TCIN	30 min		Evacuated tube collector standstill interval	81
	OCFR		OFF		Option collector frost protection	82
		CFR O	40 °F		Antifreeze temperature collector on	82
		CFR F	42 °F		Antifreeze temperature collector off	82
LLOGI >					Loading logic	
	ODB >		OFF		Drainback option	84
	OOVRU*		OFF		Overrun option	84
COOL >					Cooling functions	
	OSYC**		OFF		System cooling	85
	OSTC		OFF		Tank cooling	85
	OHDP**		OFF		Heat dump	85
DT3 >					Solid fuel boiler	
	DT3O		12 °R		Switch-on difference	86
	DT3F		8 °R		Switch-off difference	86
	DT3S		20 °R		Set difference	86
	RIS3		4 °R		Rise	86
	MAX3O		140 °F		Switch-on temperature (maximum limitation)	86
	MAX3F		136 °F		Switch-off temperature (maximum limitation)	86
	MIN3O		140 °F		Switch-on temperature (minimum limitation)	86
	MIN3F		150 °F		Switch-off temperature (minimum limitation)	86
	S2DT3		3		Reference sensor heat sink	87
PUMP >					Pump speed	
	PUMP1		OnOF		Speed variant pump 1	79
	PUMP2		OnOF		Speed variant pump 2	79
	PUMP3		OnOF		Speed variant pump 3	79
MAN >					Manual mode	
	MAN1		Auto		Manual mode 1	88
	MAN2		Auto		Manual mode 2	88
	MAN3		Auto		Manual mode 3	88
	MAN4		Auto		Manual mode 4	88
BLPR >			OFF		Blocking protection	88
OTDIS >			OFF		Thermal disinfection option	89
OPARR >			OFF		Parallel relay option	90
OHQM >			OFF		Energy metering option	90
GFDS >			OFF		Registration Grundfos sensors	90
PRS* >			OFF		Pressure monitoring option	92
DATE >					Enter date	92
LANG >			En		Language	93
UNIT >			°F		Unit	92
OSDC >					SD card option	93
CODE			0000		User code	96
RESET			OFF		Factory setting	

* This channel is only available if the Grundfos sensors have been registered in the **GFDS** channel.

** are blocked against each other

System 9

Solar system with 1 tank and heating circuit return preheating

The controller calculates the temperature difference between collector sensor S1 and tank sensor S2. If the difference is larger than or identical to the adjusted switch-on temperature difference, the pump (R1) will be switched on and the tank will be loaded until the switch-off temperature

difference or the maximum tank temperature is reached. With another temperature differential function (S3/S4) heating circuit return preheating (heating circuit backup) is possible via a valve (R2).

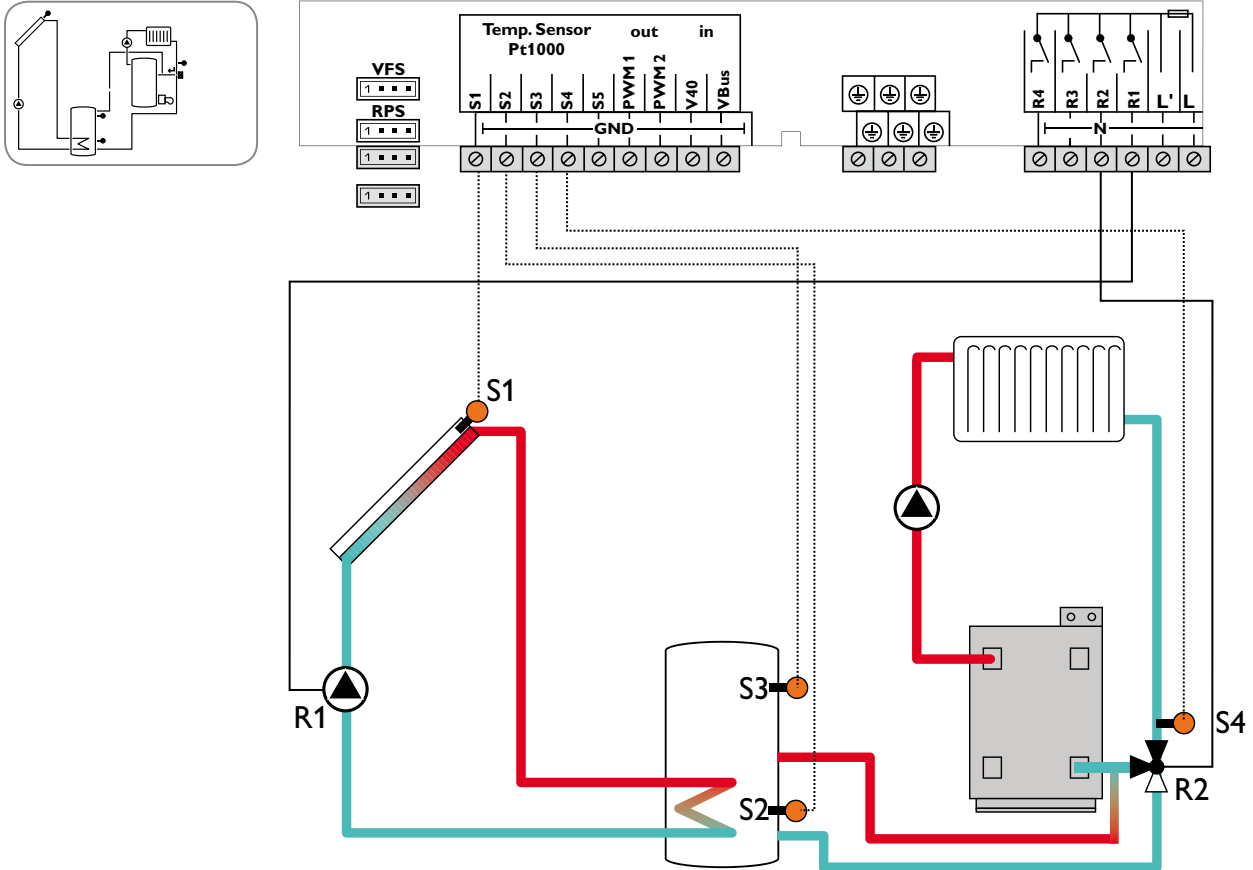

Sensor/Terminal	Designation	Description
S1	TCOL	Temperature collector
S2	TSTB	Temperature tank bottom
S3	TSTR	Temp. tank return preheating
S4	TRET	Temperature - return
S5		Optional sensor for measurement purposes or options
VFS		
RPS		
V40		

Relay	Description
R1	Solar pump
R2	Return preheating
R3	optional:
R4	Thermal disinfection
	Booster pump
	Parallel relay
	Heat dump

Adjustment channels						
Channel	Sub channel 1	Sub channel 2	Factory setting	Change to	Description	Page
ARR			1	9	System	78
LOAD >					Loading	
	DT O		12 °R		Switch-on temperature difference	78
	DT F		8 °R		Switch-off temperature difference	78
	DT S		20 °R		Set temperature difference	78
	RIS		4 °R		Rise	78
	S MAX		140 °F		Tank maximum limitation	78
	SMAXS		2		Sensor tank max	79
COL >					Collector	
	CEM		270 °F		Collector emergency temperature	80
	OCCO**		OFF		Option collector cooling	80
		C MAX	230 °F		Maximum collector temperature	80
	O CMI		OFF		Option collector minimum limitation	80

Adjustment channels						
Channel	Sub channel 1	Sub channel 2	Factory setting	Change to	Description	Page
		CMIN	50 °F		Minimum collector temperature	80
	OTCO		OFF		Option evacuated tube collector function	81
		TCST	07:00		Evacuated tube collector starting time	81
		TCEN	19:00		Evacuated tube collector ending time	81
		TCRU	30 s		Evacuated tube collector runtime	81
		TCIN	30 min		Evacuated tube collector standstill interval	81
	OCFR		OFF		Option collector frost protection	82
		CFR O	40 °F		Antifreeze temperature collector on	82
		CFR F	42 °F		Antifreeze temperature collector off	82
LLOGI >					Loading logic	
	ODB >		OFF		Drainback option	84
	OOVRU*		OFF		Overrun option	84
COOL >					Cooling functions	
	OSYC**		OFF		System cooling	85
	OSTC		OFF		Tank cooling	85
	OHDP**		OFF		Heat dump	85
DT3 >					Solid fuel boiler	
	DT3O		12 °R		Switch-on difference	86
	DT3F		8 °R		Switch-off difference	86
	S2DT3		3		Reference sensor heat source	87
PUMP >					Pump speed	
	PUMP1		OnOF		Speed variant pump 1	79
	PUMP2		OnOF		Speed variant pump 2	79
	PUMP3		OnOF		Speed variant pump 3	79
MAN >					Manual mode	
	MAN1		Auto		Manual mode 1	88
	MAN2		Auto		Manual mode 2	88
	MAN3		Auto		Manual mode 3	88
	MAN4		Auto		Manual mode 4	88
BLPR >			OFF		Blocking protection	88
OTDIS >			OFF		Thermal disinfection option	89
OPARR >			OFF		Parallel relay option	90
OHQM >			OFF		Energy metering option	90
GFDS >			OFF		Registration Grundfos sensors	90
PRS* >			OFF		Pressure monitoring option	92
DATE >			OFF		Enter date	92
LANG >			En		Language	93
UNIT >			°F		Unit	92
OSDC >					SD card option	93
CODE			0000		User code	96
RESET			OFF		Factory setting	

* This channel is only available if the Grundfos sensors have been registered in the **GFDS** channel.

** are blocked against each other

System 10

Solar system with 1 tank, heating circuit return preheating and thermostatic backup heating

The controller calculates the temperature difference between collector sensor S1 and tank sensor S2. If the difference is larger than or identical to the adjusted switch-on temperature difference, the pump (R1) will be switched on and the tank will be loaded until the switch-off temperature

difference or the maximum tank temperature is reached. With another temperature differential function (S3/S4) heating circuit backup (heating circuit return preheating) is possible via a valve (R2). With a thermostat function (S3) domestic hot water backup heating (R4) can be carried out.

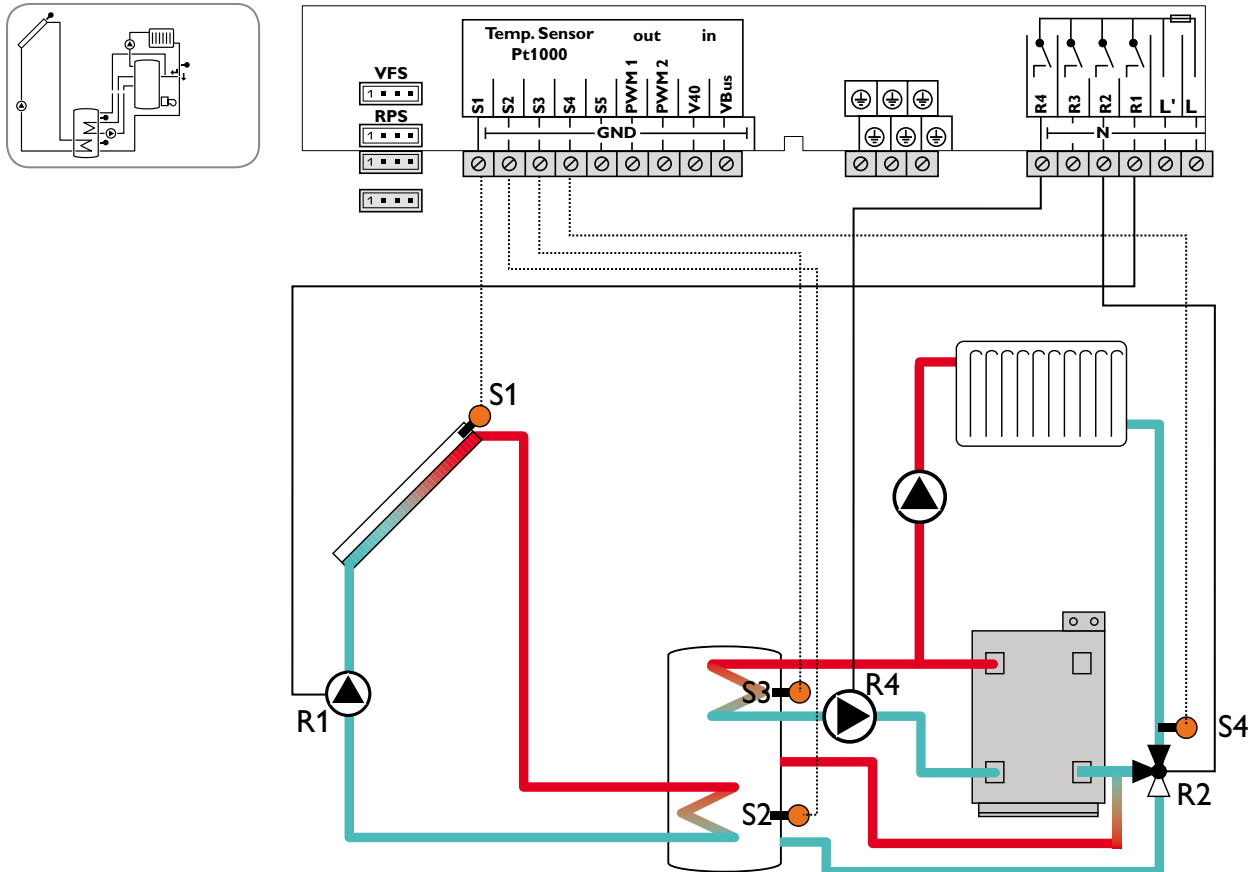

Sensor/Terminal	Designation	Description
S1	TCOL	Temperature collector
S2	TSTB	Temperature tank bottom
S3	TSTT/TSTR	Temperature tank top/ Temp. tank return preheating
S4	TRET	Temperature - return
S5		Optional sensor for measurement purposes or options
VFS		
RPS		
V40		

Relay	Description
R1	Solar pump
R2	Return preheating
R3	optional: Thermal disinfection Booster pump Parallel relay Heat dump
R4	Backup heating/tank loading pump

Adjustment channels						
Channel	Sub channel 1	Sub channel 2	Factory setting	Change to	Description	Page
ARR			1	10	System	78
LOAD >					Loading	
	DT O		12 °R		Switch-on temperature difference	78
	DT F		8 °R		Switch-off temperature difference	78
	DT S		20 °R		Set temperature difference	78
	RIS		4 °R		Rise	78
	S MAX		140 °F		Tank maximum limitation	78
	S MAXS		2		Sensor tank max	79
COL >					Collector	
	CEM		270 °F		Collector emergency temperature	80
	OCCO*		OFF		Option collector cooling	80

Adjustment channels						
Channel	Sub channel 1	Sub channel 2	Factory setting	Change to	Description	Page
		CMAX	230 °F		Maximum collector temperature	80
	OCMI		OFF		Option collector minimum limitation	80
		CMIN	50 °F		Minimum collector temperature	80
	OTCO		OFF		Option evacuated tube collector function	81
		TCST	07:00		Evacuated tube collector starting time	81
		TCEN	19:00		Evacuated tube collector ending time	81
		TCRU	30 s		Evacuated tube collector runtime	81
		TCIN	30 min		Evacuated tube collector standstill interval	81
	OCFR		OFF		Option collector frost protection	82
		CFR O	40 °F		Antifreeze temperature collector on	82
		CFR F	42 °F		Antifreeze temperature collector off	82
LLOGI >					Loading logic	
	ODB >		OFF		Drainback option	84
	OOVRU*		OFF		Overrun option	84
COOL >					Cooling functions	
	OSYC**		OFF		System cooling	85
	OSTC		OFF		Tank cooling	85
	OHDP**		OFF		Heat dump	85
DT3 >					Return preheating	
	DT3O		12 °R		Switch-on difference	86
	DT3F		8 °R		Switch-off difference	86
	S2DT3		3		Reference sensor heat source	87
AH >					Backup heating option	
	AH O		110 °F		Backup heating switch-on temperature	87
	AH F		120 °F		Backup heating switch-off temperature	87
	t1O		06:00		Switch-on time 1	88
	t1F		22:00		Switch-off time 1	88
	t2O		00:00		Switch-on time 2	88
	t2F		00:00		Switch-off time 2	88
	t3O		00:00		Switch-on time 3	88
	t3F		00:00		Switch-off time 3	88
PUMP >					Pump speed	
	PUMP1		OnOF		Speed variant pump 1	79
	PUMP2		OnOF		Speed variant pump 2	79
	PUMP3		OnOF		Speed variant pump 3	79
MAN >					Manual mode	
	MAN1		Auto		Manual mode 1	88
	MAN2		Auto		Manual mode 2	88
	MAN3		Auto		Manual mode 3	88
	MAN4		Auto		Manual mode 4	88
BLPR >			OFF		Blocking protection	88
OTDIS >			OFF		Thermal disinfection option	89
OPARR >			OFF		Parallel relay option	90
OHQM >			OFF		Energy metering option	90
GFDS >			OFF		Registration Grundfos sensors	90
PRS* >			OFF		Pressure monitoring option	92
DATE >					Enter date	92
LANG >			En		Language	93
UNIT >			°F		Unit	92
OSDC >					SD card option	93
CODE			0000		User code	96
RESET			OFF		Factory setting	

* This channel is only available if the Grundfos sensors have been registered in the **GFDS** channel.

** are blocked against each other

System 11

Solar system with vertical tank loading and heat exchange control

The controller compares the temperature at sensor S1 to the temperatures at sensors S2 and S3. If the measured temperature differences are higher than the adjusted switch-on temperature differences, the pump (R1) will be activated and the corresponding tank zone will be loaded up to the adjusted maximum temperature via the valve (R3).

The priority logic effects prior loading of the upper zone of the tank.

Heat exchange control to an existent tank via an additional pump (R2) can be carried out with another temperature differential function (S3 heat source/S4 heat sink).

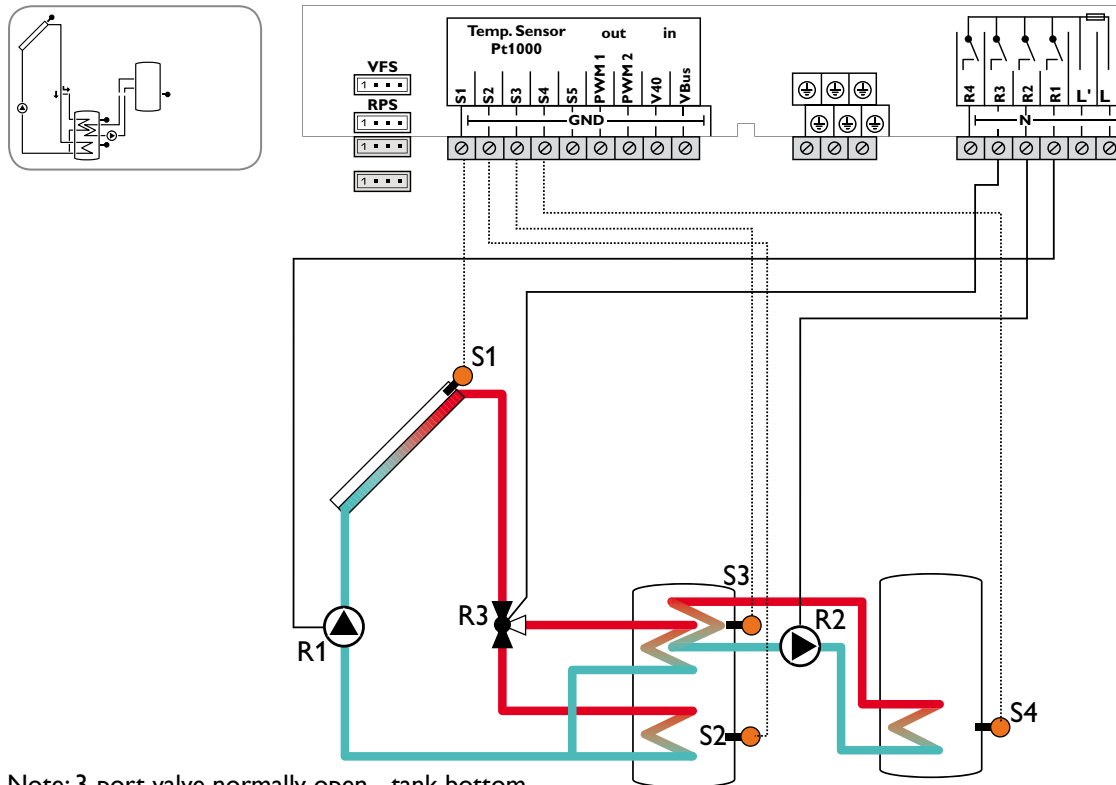

Note: 3-port valve normally open - tank bottom

Sensor/Terminal	Designation	Description
S1	TCOL	Temperature collector
S2	TST1B	Temperature tank 1 bottom
S3	TSTT	Temperature tank 1 top
S4	TST2B	Temperature tank 2 bottom
S5		Optional sensor for measurement purposes or options
VFS		
RPS		
V40		

Relay	Description
R1	Solar pump
R2	Heat exchange pump
R3	3-port valve tank top/bottom
R4	optional: Thermal disinfection Parallel relay Heat dump

Adjustment channels						
Channel	Sub channel 1	Sub channel 2	Factory setting	Change to	Description	Page
ARR			1	11	System	78
LOAD1 >					Loading 1	
	DT1O		12 °R		Switch-on temperature difference 1	78
	DT1F		8 °R		Switch-off temperature difference 1	78
	DT1S		20 °R		Set temperature difference 1	78
	RIS1		4 °R		Rise 1	78
	S1MAX		140 °F		Tank maximum limitation 1	78
	SMXS1		2		Sensor tank max 1	79
LOAD2 >					Loading 2	
	DT2O		12 °R		Switch-on temperature difference 2	78
	DT2F		8 °R		Switch-off temperature difference 2	78
	DT2S		20 °R		Set temperature difference 2	78
	RIS2		4 °R		Rise 2	78
	S2MAX		140 °F		Tank maximum limitation 2	78

Adjustment channels						
Channel	Sub channel 1	Sub channel 2	Factory setting	Change to	Description	Page
	LST2		ON		Loading tank 2	79
COL >					Collector	
	CEM		270 °F		Collector emergency temperature	80
	OCCO**		OFF		Option collector cooling	80
		CMAX	230 °F		Maximum collector temperature	80
	OCMI		OFF		Option collector minimum limitation	80
		CMIN	50 °F		Minimum collector temperature	80
	OTCO		OFF		Option evacuated tube collector function	81
		TCST	07:00		Evacuated tube collector starting time	81
		TCEN	19:00		Evacuated tube collector ending time	81
		TCRU	30 s		Evacuated tube collector runtime	81
		TCIN	30 min		Evacuated tube collector standstill interval	81
	OCFR		OFF		Option collector frost protection	82
		CFR O	40 °F		Antifreeze temperature collector on	82
		CFR F	42 °F		Antifreeze temperature collector off	82
LLOGI >					Loading logic	
	PRIO				Priority logic	82
		PRIO	2		Priority logic	82
		OSTS	OFF		Tank set option	83
		TST1	120 °F		Set tank temperature tank 1	83
		TST2	120 °F		Set tank temperature tank 2	83
	tLB		2 min		Loading break time	82
	tRUN		15 min		Circulation runtime	82
	PSPEE		OFF		Pause speed option	83
	PDELA		OFF		Pump delay option	83
	OOVRU*		OFF		Overrun option	84
COOL >					Cooling functions	
	OSYC**		OFF		System cooling	85
	OSTC		OFF		Tank cooling	85
	OHDP**		OFF		Heat dump	85
DT3 >					Heat exchange	
	DT3O		12 °R		Switch-on difference	86
	DT3F		8 °R		Switch-off difference	86
	DT3S		20 °R		Set difference	86
	RIS3		4 °R		Rise	86
	MAX3O		140 °F		Switch-on temperature (maximum limitation)	86
	MAX3F		136 °F		Switch-off temperature (maximum limitation)	86
	MIN3O		40 °F		Switch-on temperature (minimum limitation)	86
	MIN3F		50 °F		Switch-off temperature (minimum limitation)	86
	S2DT3		4		Reference sensor heat sink	87
PUMP >					Pump speed	
	PUMP1		OnOF		Speed variant pump 1	79
	PUMP2		OnOF		Speed variant pump 2	79
	PUMP3		OnOF		Speed variant pump 3	79
MAN >					Manual mode	
	MAN1		Auto		Manual mode 1	88
	MAN2		Auto		Manual mode 2	88
	MAN3		Auto		Manual mode 3	88
	MAN4		Auto		Manual mode 4	88
BLPR >			OFF		Blocking protection	88
OTDIS >			OFF		Thermal disinfection option	89
OPARR >			OFF		Parallel relay option	90
OHQM >			OFF		Energy metering option	90
GFDS >			OFF		Registration Grundfos sensors	90
PRS* >			OFF		Pressure monitoring option	92
DATE >					Enter date	92
LANG >			En		Language	93
UNIT >			°F		Unit	92
OSDC >					SD card option	93
CODE			0000		User code	96
RESET			OFF		Factory setting	

* This channel is only available if the Grundfos sensors have been registered in the **GFDS** channel.

** are blocked against each other

System 12

Solar system with vertical tank loading and thermostatic backup heating

The controller compares the temperature at sensor S1 to the temperatures at sensors S2 and S3. If the measured temperature differences are higher than the adjusted switch-on temperature differences, the pump (R1) will be activated and the corresponding tank zone will be loaded up to the

adjusted maximum temperature via the valve (R3). The priority logic effects prior loading of the upper zone of the tank. Domestic hot water backup heating (R4) can be carried out with a thermostat function (S3).

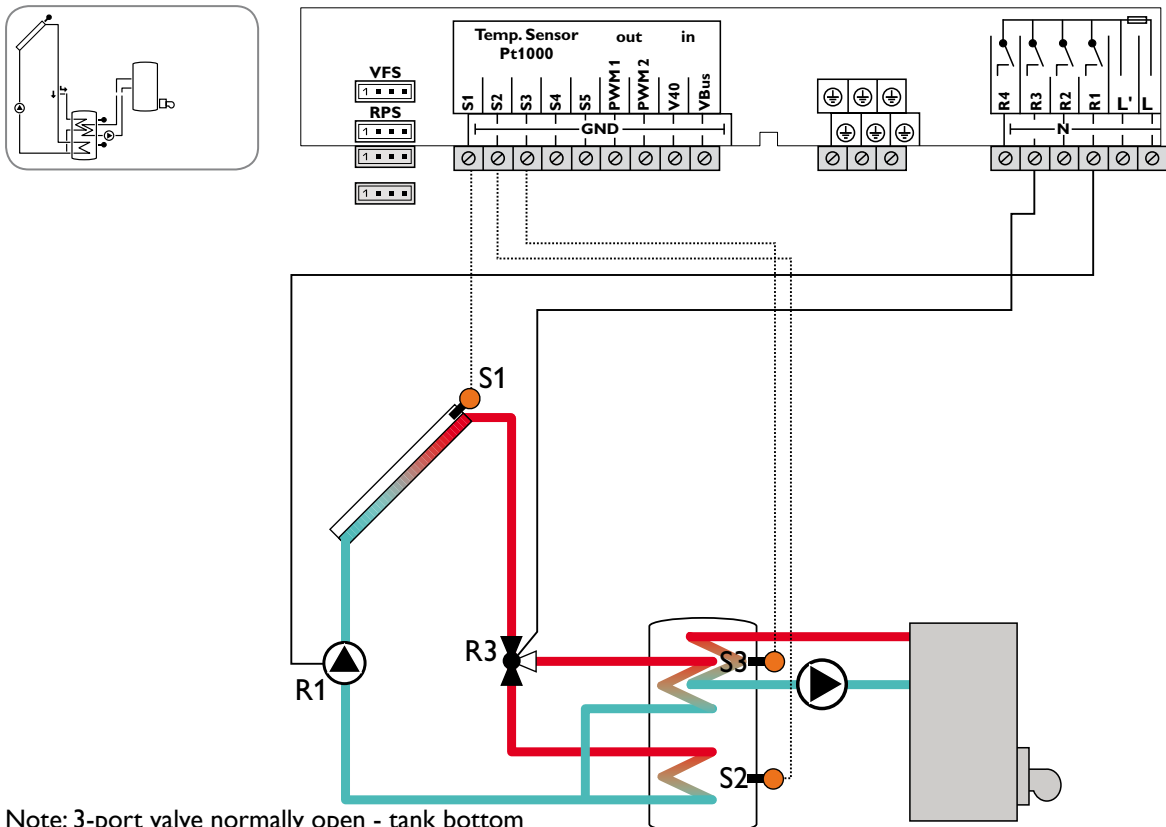

Note: 3-port valve normally open - tank bottom

Sensor/Terminal	Designation	Description
S1	TCOL	Temperature collector
S2	TSTB	Temperature tank bottom
S3	TSTT	Temperature tank top
S4		Optional sensor for measurement purposes or options
S5		Optional sensor for measurement purposes or options
VFS		
RPS		
V40		

Relay	Description
R1	Solar pump
R2	optional: Thermal disinfection Parallel relay Heat dump
R3	3-port valve tank top/bottom
R4	Backup heating/tank loading pump

Adjustment channels						
Channel	Sub channel 1	Sub channel 2	Factory setting	Change to	Description	Page
ARR			1	12	System	78
LOAD1 >					Loading 1	
	DT1O		12 °R		Switch-on temperature difference 1	78
	DT1F		8 °R		Switch-off temperature difference 1	78
	DT1S		20 °R		Set temperature difference 1	78
	RIS1		4 °R		Rise 1	78
	S1MAX		60		Tank maximum limitation 1	78
	SMXS1		2		Sensor tank max 1	79
LOAD2 >					Loading 2	
	DT2O		12 °R		Switch-on temperature difference 2	78
	DT2F		8 °R		Switch-off temperature difference 2	78
	DT2S		20 °R		Set temperature difference 2	78
	RIS2		4 °R		Rise 2	78

Adjustment channels						
Channel	Sub channel 1	Sub channel 2	Factory setting	Change to	Description	Page
	S2MAX		140 °F		Tank maximum limitation 2	78
	LST2		ON		Loading tank 2	79
COL >					Collector	
	CEM		270 °F		Collector emergency temperature	80
	OCCO**		OFF		Option collector cooling	80
		CMAX	230 °F		Maximum collector temperature	80
	OCCI		OFF		Option collector minimum limitation	80
		CMIN	50 °F		Minimum collector temperature	80
	OTCO		OFF		Option evacuated tube collector function	81
		TCST	07:00		Evacuated tube collector starting time	81
		TCEN	19:00		Evacuated tube collector ending time	81
		TCRU	30 s		Evacuated tube collector runtime	81
		TCIN	30 min		Evacuated tube collector standstill interval	81
	O CFR		OFF		Option collector frost protection	82
		CFR O	40 °F		Antifreeze temperature collector on	82
		CFR F	42 °F		Antifreeze temperature collector off	82
LLOGI >					Loading logic	
	PRIO				Priority logic	82
		PRIO	2		Priority logic	82
		OSTS	OFF		Tank set option	83
		TST1	120 °F		Set tank temperature tank 1	83
		TST2	120 °F		Set tank temperature tank 2	83
	tLB		2 min		Loading break time	82
	tRUN		15 min		Circulation runtime	82
	PSPEE		OFF		Pause speed option	83
	PDELA		OFF		Pump delay option	83
	OVRU*		OFF		Overrun option	84
COOL >					Cooling functions	
	OSYC**		OFF		System cooling	85
	OSTC		OFF		Tank cooling	85
	OHDP**		OFF		Heat dump	85
AH >					Backup heating option	
	AH O		110 °F		Backup heating switch-on temperature	87
	AH F		120 °F		Backup heating switch-off temperature	87
	t1O		06:00		Switch-on time 1	88
	t1F		22:00		Switch-off time 1	88
	t2O		00:00		Switch-on time 2	88
	t2F		00:00		Switch-off time 2	88
	t3O		00:00		Switch-on time 3	88
	t3F		00:00		Switch-off time 3	88
PUMP >					Pump speed	
	PUMP1		OnOF		Speed variant pump 1	79
	PUMP2		OnOF		Speed variant pump 2	79
	PUMP3		OnOF		Speed variant pump 3	79
MAN >					Manual mode	
	MAN1		Auto		Manual mode 1	88
	MAN2		Auto		Manual mode 2	88
	MAN3		Auto		Manual mode 3	88
	MAN4		Auto		Manual mode 4	88
BLPR >			OFF		Blocking protection	88
OTDIS >			OFF		Thermal disinfection option	89
OPARR >			OFF		Parallel relay option	90
OHQM >			OFF		Energy metering option	90
GFDS >			OFF		Registration Grundfos sensors	90
PRS* >			OFF		Pressure monitoring option	92
DATE >					Enter date	92
LANG >			En		Language	93
UNIT >			°F		Unit	92
OSDC >					SD card option	93
CODE >			0000		User code	96
RESET			OFF		Factory setting	

* This channel is only available if the Grundfos sensors have been registered in the **GFDS** channel.

** are blocked against each other

System 13

Solar system with vertical tank loading and backup heating with solid fuel boiler

The controller compares the temperature at sensor S1 to the temperatures at sensors S2 and S3. If the measured temperature differences are higher than the adjusted switch-on temperature differences, the pump (R1) will be activated and the corresponding tank zone will be loaded up to the adju-

sted maximum temperature via the valve (R4). The priority logic effects prior loading of the upper zone of the tank. With another temperature differential function (S4/S3), backup heating of the tank can be carried out with a solid fuel boiler (R3).

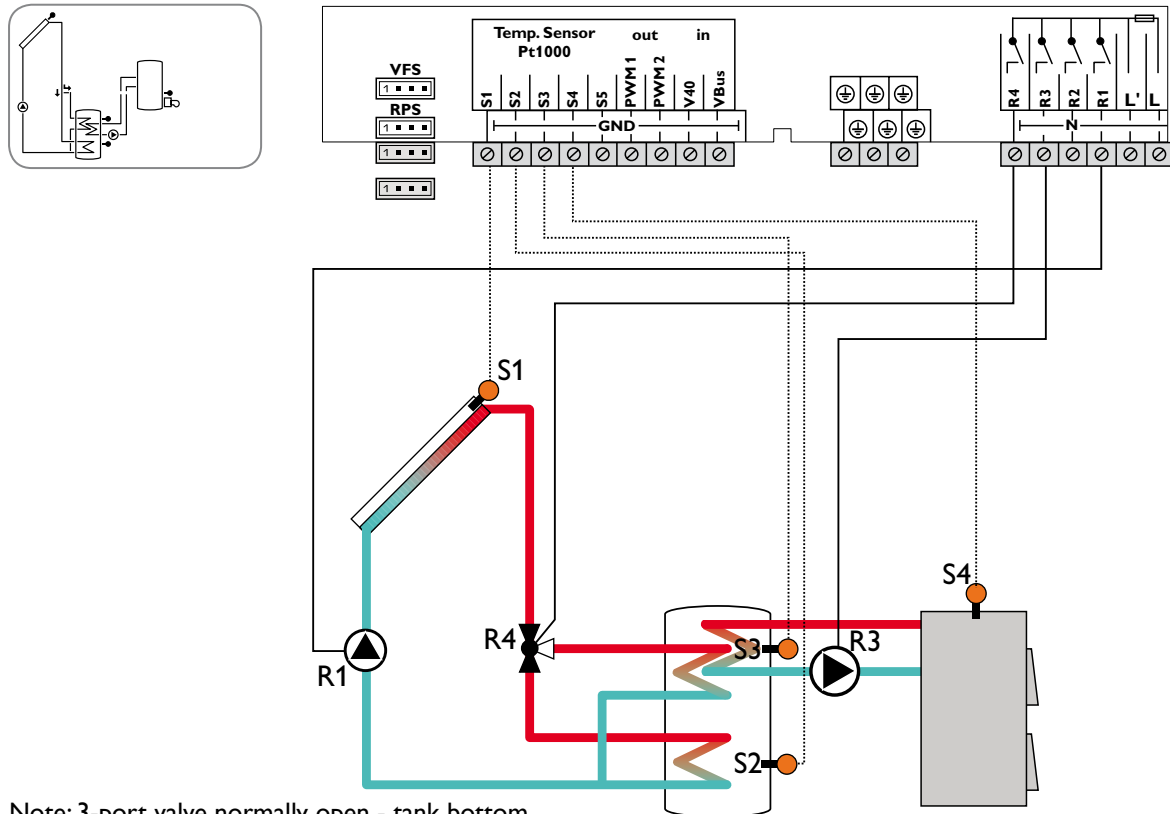

Note: 3-port valve normally open - tank bottom

Sensor/Terminal	Designation	Description
S1	TCOL	Temperature collector
S2	TSTB	Temperature tank bottom
S3	TSTT	Temperature tank top
S4	TSTB	Temperature solid fuel boiler
S5		Optional sensor for measurement purposes or options
VFS		
RPS		
V40		

Relay	Description
R1	Solar pump
R2	optional: Thermal disinfection Parallel relay
R3	Heat dump
R4	Loading pump/solid fuel boiler 3-port valve tank top/bottom

Adjustment channels						
Channel	Sub channel 1	Sub channel 2	Factory setting	Change to	Description	Page
ARR			1	13	System	78
LOAD1 >					Loading 1	
	DT1O		12 °R		Switch-on temperature difference 1	78
	DT1F		8 °R		Switch-off temperature difference 1	78
	DT1S		20 °R		Set temperature difference 1	78
	RIS1		4 °R		Rise 1	78
	S1MAX		140 °F		Tank maximum limitation 1	78
	SMXS1		2		Sensor tank max 1	79
LOAD2 >					Loading 2	
	DT2O		12 °R		Switch-on temperature difference 2	78
	DT2F		8 °R		Switch-off temperature difference 2	78
	DT2S		20 °R		Set temperature difference 2	78
	RIS2		4 °R		Rise 2	78
	S2MAX		140 °F		Tank maximum limitation 2	78

Adjustment channels						
Channel	Sub channel 1	Sub channel 2	Factory setting	Change to	Description	Page
	LST2		ON		Loading tank 2	79
COL >					Collector	
	CEM		270 °F		Collector emergency temperature	80
	OCCO**		OFF		Option collector cooling	80
		CMAX	230 °F		Maximum collector temperature	80
	OCMI		OFF		Option collector minimum limitation	80
		CMIN	50 °F		Minimum collector temperature	80
	OTCO		OFF		Option evacuated tube collector function	81
		TCST	07:00		Evacuated tube collector starting time	81
		TCEN	19:00		Evacuated tube collector ending time	81
		TCRU	30 s		Evacuated tube collector runtime	81
		TCIN	30 min		Evacuated tube collector standstill interval	81
	OCFR		OFF		Option collector frost protection	82
		CFR O	40 °F		Antifreeze temperature collector on	82
		CFR F	42 °F		Antifreeze temperature collector off	82
LLOGI >					Loading logic	
	PRIO				Priority logic	82
		PRIO	2		Priority logic	82
		OSTS	OFF		Tank set option	83
		TST1	120 °F		Set tank temperature tank 1	83
		TST2	120 °F		Set tank temperature tank 2	83
	tLB		2 min		Loading break time	82
	tRUN		15 min		Circulation runtime	82
	PSPEE		OFF		Pause speed option	83
	PDELA		OFF		Pump delay option	83
	OOVRU*		OFF		Overrun option	84
COOL >					Cooling functions	
	OSYC**		OFF		System cooling	85
	OSTC		OFF		Tank cooling	85
	OHDP**		OFF		Heat dump	85
DT3 >					Solid fuel boiler	
	DT3O		12 °R		Switch-on difference	86
	DT3F		8 °R		Switch-off difference	86
	DT3S		20 °R		Set difference	86
	RIS3		4 °R		Rise	86
	MAX3O		140 °F		Switch-on temperature (maximum limitation)	86
	MAX3F		136 °F		Switch-off temperature (maximum limitation)	86
	MIN3O		140 °F		Switch-on temperature (minimum limitation)	86
	MIN3F		149 °F		Switch-off temperature (minimum limitation)	86
	S2DT3		3		Reference sensor heat sink	87
PUMP >					Pump speed	
	PUMP1		OnOF		Speed variant pump 1	79
	PUMP2		OnOF		Speed variant pump 2	79
	PUMP3		OnOF		Speed variant pump 3	79
MAN >					Manual mode	
	MAN1		Auto		Manual mode 1	88
	MAN2		Auto		Manual mode 2	88
	MAN3		Auto		Manual mode 3	88
	MAN4		Auto		Manual mode 4	88
BLPR >			OFF		Blocking protection	88
OTDIS >			OFF		Thermal disinfection option	89
OPARR >			OFF		Parallel relay option	90
OHQM >			OFF		Energy metering option	90
GFDS >			OFF		Registration Grundfos sensors	90
PRS* >			OFF		Pressure monitoring option	92
DATE >					Enter date	92
LANG >			En		Language	93
UNIT >			°F		Unit	92
OSDC >					SD card option	93
CODE			0000		User code	96
RESET			OFF		Factory setting	

* This channel is only available if the Grundfos sensors have been registered in the GFDS channel.

**are blocked against each other

System 14

Solar system with vertical tank loading and return preheating

The controller compares the temperature at sensor S1 to the temperatures at sensors S2 and S3. If the measured temperature differences are higher than the adjusted switch-on temperature differences, the pump (R1) will be activated and the corresponding tank zone will be loaded up to the

adjusted maximum temperature via the valve (R3). The priority logic effects prior loading of the upper zone of the tank. With another temperature differential function (S3-heat source/S4-heat sink) heating circuit return preheating (heating circuit backup) is possible via another valve (R2).

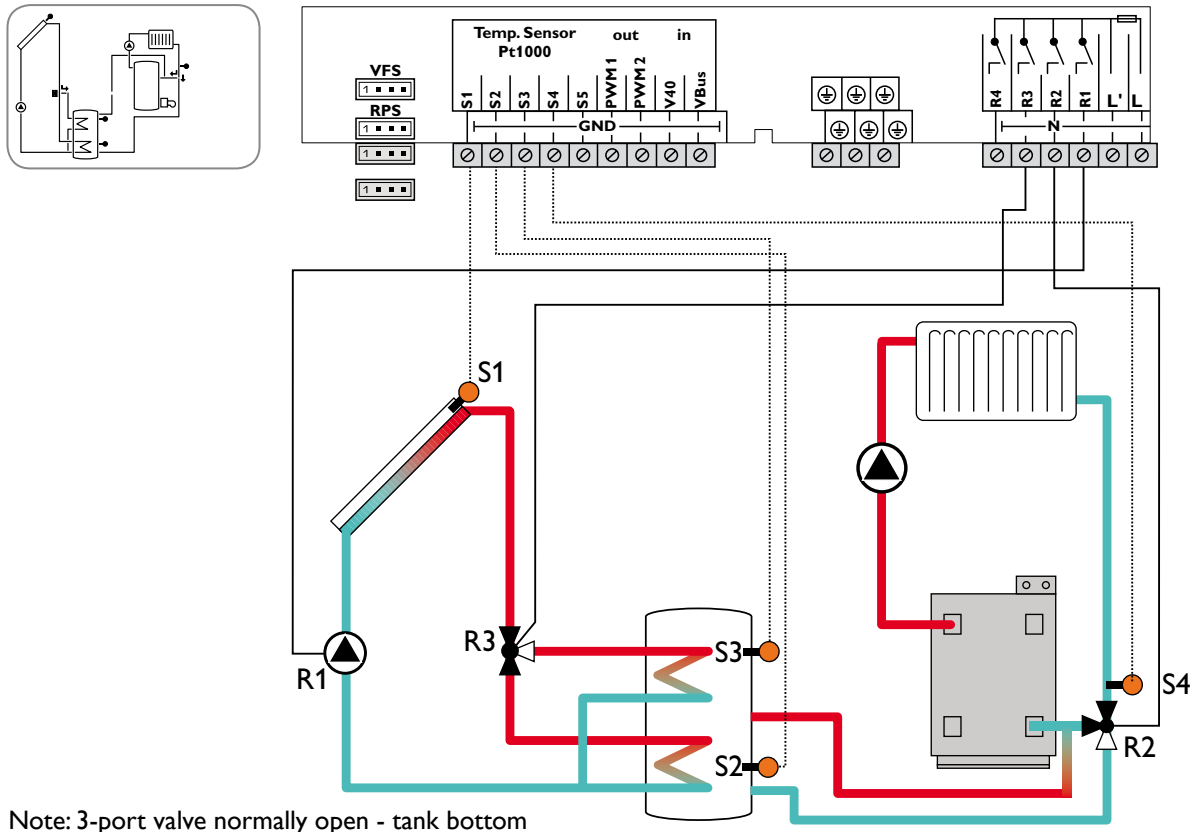

Note: 3-port valve normally open - tank bottom

Sensor/Terminal	Designation	Description
S1	TCOL	Temperature collector
S2	TSTB	Temperature tank bottom
S3	TSTT/TSTR	Temperature tank top/ Temp. tank return preheating
S4	TRET	Temperature return
S5		Optional sensor for measurement purposes or options
VFS		
RPS		
V40		

Relay	Description
R1	Solar pump
R2	Return preheating
R3	3-port valve tank top/bottom
R4	optional: Thermal disinfection Parallel relay Heat dump

Adjustment channels						
Channel	Sub channel 1	Sub channel 2	Factory setting	Change to	Description	Page
ARR			1	14	System	78
LOAD1 >					Loading 1	
	DT1O		12 °R		Switch-on temperature difference 1	78
	DT1F		8 °R		Switch-off temperature difference 1	78
	DT1S		20 °R		Set temperature difference 1	78
	RIS1		4 °R		Rise 1	78
	S1MAX		140 °F		Tank maximum limitation 1	78
	SMXS1		2		Sensor tank max 1	79
LOAD2 >					Loading 2	
	DT2O		12 °R		Switch-on temperature difference 2	78
	DT2F		8 °R		Switch-off temperature difference 2	78
	DT2S		20 °R		Set temperature difference 2	78
	RIS2		4 °R		Rise 2	78

Adjustment channels						
Channel	Sub channel 1	Sub channel 2	Factory setting	Change to	Description	Page
	S2MAX		140 °F		Tank maximum limitation 2	78
	LST2		ON		Loading tank 2	79
COL >					Collector	
	CEM		270 °F		Collector emergency temperature	80
	OCCO**		OFF		Option collector cooling	80
		CMAX	230 °F		Maximum collector temperature	80
	OCMI		OFF		Option collector minimum limitation	80
		CMIN	50 °F		Minimum collector temperature	80
	OTCO		OFF		Option evacuated evacuated tube collector function	81
		TCST	07:00		Evacuated evacuated tube collector starting time	81
		TCEN	19:00		Evacuated evacuated tube collector ending time	81
		TCRU	30 s		Evacuated tube collector runtime	81
		TCIN	30 min		Evacuated evacuated tube collector standstill interval	81
	OCFR		OFF		Option collector frost protection	82
		CFR O	40 °F		Antifreeze temperature collector on	82
		CFR F	42 °F		Antifreeze temperature collector off	82
LLOGI >					Loading logic	
	PRIO				Priority logic	82
		PRIO	2		Priority logic	82
		OSTS	OFF		Tank set option	83
		TST1	120 °F		Set tank temperature tank 1	83
		TST2	120 °F		Set tank temperature tank 2	83
	tLB		2 min		Loading break time	82
	tRUN		15 min		Circulation runtime	82
	PSPEE		OFF		Pause speed option	83
	PDELA		OFF		Pump delay option	83
	OOVRU*		OFF		Overrun option	84
COOL >					Cooling functions	
	OSYC**		OFF		System cooling	85
	OSTC		OFF		Tank cooling	85
	OHDP**		OFF		Heat dump	85
DT3 >					Return preheating	
	DT3O		12 °R		Switch-on difference	86
	DT3F		8 °R		Switch-off difference	86
	S2DT3		3		Reference sensor heat source	87
PUMP >					Pump speed	
	PUMP1		OnOF		Speed variant pump 1	79
	PUMP2		OnOF		Speed variant pump 2	79
	PUMP3		OnOF		Speed variant pump 3	79
MAN >					Manual mode	
	MAN1		Auto		Manual mode 1	88
	MAN2		Auto		Manual mode 2	88
	MAN3		Auto		Manual mode 3	88
	MAN4		Auto		Manual mode 4	88
BLPR >			OFF		Blocking protection	88
OTDIS >			OFF		Thermal disinfection option	89
OPARR >			OFF		Parallel relay option	90
OHQM >			OFF		Energy metering option	90
GFDS >			OFF		Registration Grundfos sensors	90
PRS* >			OFF		Pressure monitoring option	92
DATE >					Enter date	92
LANG >			En		Language	93
UNIT >			°F		Unit	92
OSDC >					SD card option	93
CODE			0000		User code	96
RESET			OFF		Factory setting	

* This channel is only available if the Grundfos sensors have been registered in the **GFDS** channel.

** are blocked against each other

System 15

Solar system with vertical tank loading and backup heating via heating backup

The controller compares the temperature at sensor S1 to the temperatures at sensors S2 and S3. If the measured temperature differences are higher than the adjusted switch-on temperature differences, the pump (R1) will be activated and the corresponding tank zone will be loaded up to the adjusted maximum temperature at most via the valve (R3). The priority logic effects prior loading of the upper zone

of the tank.

With another temperature differential function (S3-heat source/S4-heat sink) heating circuit return preheating (heating circuit backup) is possible via another valve (R2). Domestic hot water backup heating (R4) can be carried out with a thermostat function (S3).

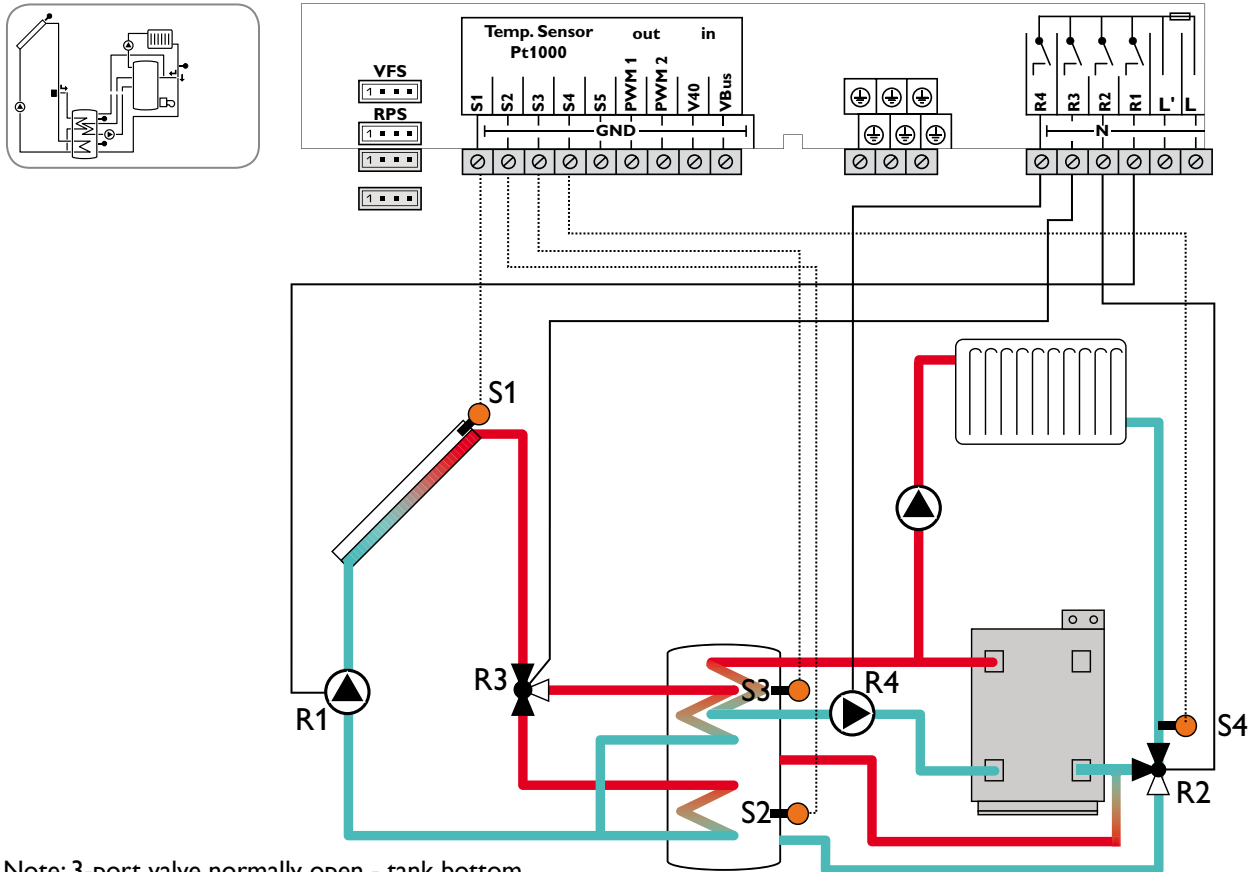

Note: 3-port valve normally open - tank bottom

Sensor/Terminal	Designation	Description
S1	TCOL	Temperature collector
S2	TSTB	Temperature tank bottom
S3	TSTT/TSTR	Temperature tank top/ Temp. tank return preheating
S4	TRET	Temperature return
S5		Optional sensor for measurement purposes or options
VFS		
RPS		
V40		

Relay	Description
R1	Solar pump
R2	Return preheating
R3	3-port valve tank top/bottom
R4	Backup heating/tank loading pump

Adjustment channels						
Channel	Sub channel 1	Sub channel 2	Factory setting	Change to	Description	Page
ARR			1	15	System	78
LOAD1 >					Loading 1	
	DT1O		12 °R		Switch-on temperature difference 1	78
	DT1F		8 °R		Switch-off temperature difference 1	78
	DT1S		20 °R		Set temperature difference 1	78
	RIS1		4 °R		Rise 1	78
	S1MAX		140 °F		Tank maximum limitation 1	78
	SMXS1		2		Sensor tank max 1	79

Adjustment channels						
Channel	Sub channel 1	Sub channel 2	Factory setting	Change to	Description	Page
LOAD2 >					Loading 2	
	DT2O		12 °R		Switch-on temperature difference 2	78
	DT2F		8 °R		Switch-off temperature difference 2	78
	DT2S		20 °R		Set temperature difference 2	78
	RIS2		4 °R		Rise 2	78
	S2MAX		140 °F		Tank maximum limitation 2	78
	LST2		ON		Loading tank 2	79
COL >					Collector	
	CEM		270 °F		Collector emergency temperature	80
	OCCO**		OFF		Option collector cooling	80
		CMAX	230 °F		Maximum collector temperature	80
	OCMI		OFF		Option collector minimum limitation	80
		CMIN	50 °F		Minimum collector temperature	80
	OTCO		OFF		Option evacuated evacuated tube collector function	81
		TCST	07:00		Evacuated evacuated tube collector starting time	81
		TCEN	19:00		Evacuated evacuated tube collector ending time	81
		TCRU	30 s		Evacuated evacuated tube collector runtime	81
		TCIN	30 min		Evacuated tube collector standstill interval	81
	OCFR		OFF		Option collector frost protection	82
		CFR O	40 °F		Antifreeze temperature collector on	82
		CFR F	42 °F		Antifreeze temperature collector off	82
LLOGI >					Loading logic	
	PRIO				Priority logic	82
		PRIO	2		Priority logic	82
		OSTS	OFF		Tank set option	83
		TST1	120 °F		Set tank temperature tank 1	83
		TST2	120 °F		Set tank temperature tank 2	83
	tLB		2 min		Loading break time	82
	tRUN		15 min		Circulation runtime	82
	PSPEE		OFF		Pause speed option	83
	PDELA		OFF		Pump delay option	83
	OOVRU*		OFF		Overrun option	84
COOL >					Cooling functions	
	OSYC**		OFF		System cooling	85
	OSTC		OFF		Tank cooling	85
	OHDP**		OFF		Heat dump	85
DT3 >					Return preheating	
	DT3O		12 °R		Switch-on difference	86
	DT3F		8 °R		Switch-off difference	86
	S2DT3		3		Reference sensor heat source	87
AH >					Backup heating option	
	AH O		110 °F		Backup heating switch-on temperature	87
	AH F		120 °F		Backup heating switch-off temperature	87
	t1O		06:00		Switch-on time 1	88
	t1F		22:00		Switch-off time 1	88
	t2O		00:00		Switch-on time 2	88
	t2F		00:00		Switch-off time 2	88
	t3O		00:00		Switch-on time 3	88
	t3F		00:00		Switch-off time 3	88
PUMP >					Pump speed	
	PUMP1		OnOF		Speed variant pump 1	79
	PUMP2		OnOF		Speed variant pump 2	79
	PUMP3		OnOF		Speed variant pump 3	79
MAN >					Manual mode	
	MAN1		Auto		Manual mode 1	88
	MAN2		Auto		Manual mode 2	88
	MAN3		Auto		Manual mode 3	88
	MAN4		Auto		Manual mode 4	88
BLPR >			OFF		Blocking protection	88
OTDIS >			OFF		Thermal disinfection option	89
OPARR >			OFF		Parallel relay option	90

Adjustment channels						
Channel	Sub channel 1	Sub channel 2	Factory setting	Change to	Description	Page
OHQM >			OFF		Energy metering option	90
GFDS >			OFF		Registration Grundfos sensors	90
PRS* >			OFF		Pressure monitoring option	92
DATE>					Enter date	92
LANG >			En		Language	93
UNIT >			°F		Unit	92
OSDC >					SD card option	93
CODE			0000		User code	96
RESET			OFF		Factory setting	

* This channel is only available if the Grundfos sensors have been registered in the **GFDS** channel.

** are blocked against each other

System 16

2-tank solar system with valve logic and heat exchange control

The controller compares the temperature at sensor S1 to the temperatures at sensors S2 and S4. If the measured temperature differences are higher than the adjusted switch-on temperature differences, the pump (R1) will be activated and the corresponding tank zone will be loaded up to the

adjusted maximum temperature via the valve (R3). Tank 1 is loaded with priority. Heat exchange from tank 1 to tank 2 (R2) is possible with another temperature differential function (S3-heat source/S4-heat sink).

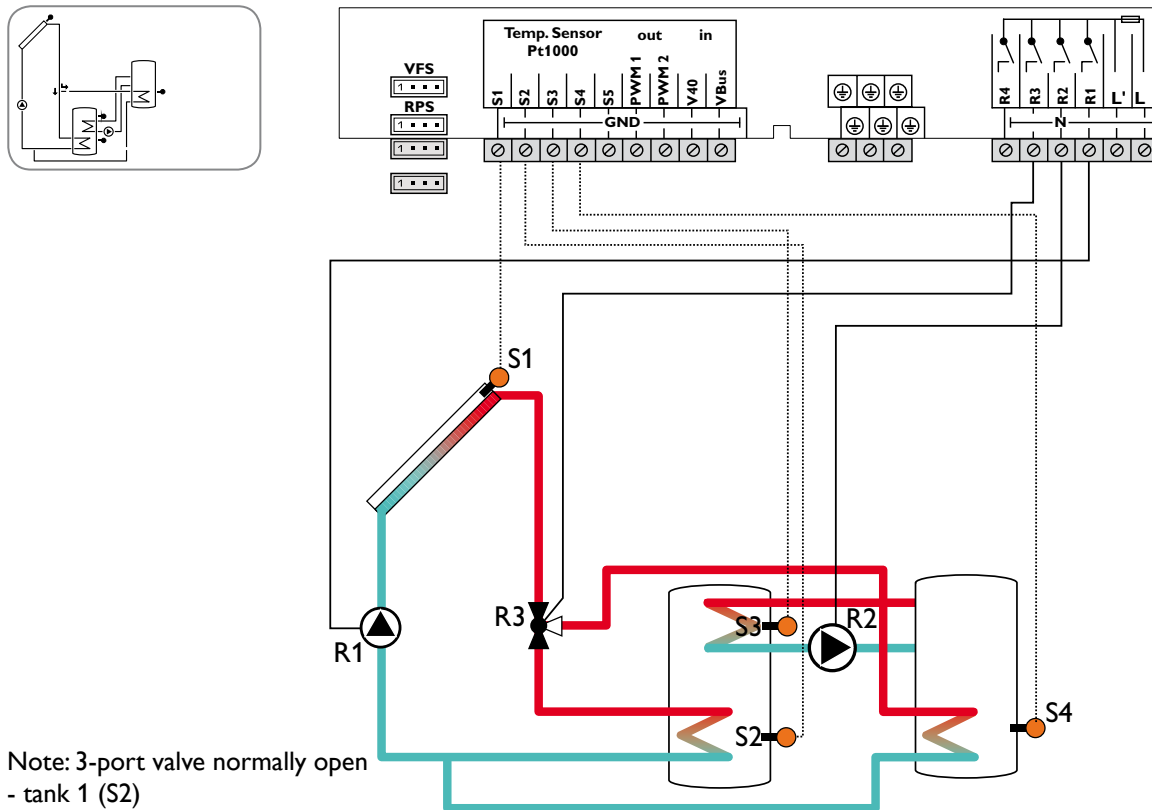

Note: 3-port valve normally open - tank 1 (S2)

Sensor/Terminal	Designation	Description
S1	TCOL	Temperature collector
S2	TST1B	Temperature tank 1 bottom
S3	TSTT	Temperature tank 1 top
S4	TST2B	Temperature tank 2 bottom
S5		Optional sensor for measurement purposes or options
VFS		
RPS		
V40		

Relay	Description
R1	Solar pump
R2	Heat exchange pump
R3	3-port valve tank 1 / 2
R4	optional: Thermal disinfection Parallel relay Heat dump

Adjustment channels						
Channel	Sub channel 1	Sub channel 2	Factory setting	Change to	Description	Page
ARR			1	16	System	78
LOAD1 >					Loading 1	
	DT1O		12 °R		Switch-on temperature difference 1	78
	DT1F		8 °R		Switch-off temperature difference 1	78
	DT1S		20 °R		Set temperature difference 1	78
	RIS1		4 °R		Rise 1	78
	S1MAX		140 °F		Tank maximum limitation 1	78
	SMXS1		2		Sensor tank max 1	79
LOAD2 >					Loading 2	
	DT2O		12 °R		Switch-on temperature difference 2	78
	DT2F		8 °R		Switch-off temperature difference 2	78
	DT2S		20 °R		Set temperature difference 2	78
	RIS2		4 °R		rise 2	78
	S2MAX		140 °F		Tank maximum limitation 2	78
	SMXS2		4		Sensor tank max 2	79
	LST2		ON		Loading tank 2	79

Adjustment channels						
Channel	Sub channel 1	Sub channel 2	Factory setting	Change to	Description	Page
COL >					Collector	
	CEM		270 °F		Collector emergency temperature	80
	OCCO**		OFF		Option collector cooling	80
		CMAX	230 °F		Maximum collector temperature	80
	OCMI		OFF		Option collector minimum limitation	80
		CMIN	50 °F		Minimum collector temperature	80
	OTCO		OFF		Option evacuated tube collector function	81
		TCST	07:00		Evacuated tube collector starting time	81
		TCEN	19:00		Evacuated tube collector ending time	81
		TCRU	30 s		Evacuated tube collector runtime	81
		TCIN	30 min		Evacuated tube collector standstill interval	81
	OCFR		OFF		Option collector frost protection	82
		CFR O	40 °F		Antifreeze temperature collector on	82
		CFR F	42 °F		Antifreeze temperature collector off	82
		FRPST	1		Antifreeze tank selection	82
LLOGI >					Loading logic	
	PRIO				Priority logic	82
		PRIO	1		Priority logic	82
		OSTS	OFF		Tank set option	83
		TST1	120 °F		Set tank temperature tank 1	83
		TST2	120 °F		Set tank temperature tank 2	83
	tLB		2 min		Loading break time	82
	tRUN		15 min		Circulation runtime	82
	PSPEE		OFF		Pause speed option	83
	PDELA		OFF		Pump delay option	83
	OOVRU*		OFF		Overrun option	84
COOL >					Cooling functions	
	OSYC**		OFF		System cooling	85
	OSTC		OFF		Tank cooling	85
	OHDP**		OFF		Heat dump	85
DT3 >					Heat exchange	
	DT3O		12 °R		Switch-on difference	86
	DT3F		8 °R		Switch-off difference	86
	DT3S		20 °R		Set difference	86
	RIS3		4 °R		Rise	86
	MAX3O		140 °F		Switch-on temperature (maximum limitation)	86
	MAX3F		136 °F		Switch-off temperature (maximum limitation)	86
	MIN3O		40 °F		Switch-on temperature (minimum limitation)	86
	MIN3F		50 °F		Switch-off temperature (minimum limitation)	86
	S2DT3		4		Reference sensor heat sink	87
PUMP >					Pump speed	
	PUMP1		OnOF		Speed variant pump 1	79
	PUMP2		OnOF		Speed variant pump 2	79
	PUMP3		OnOF		Speed variant pump 3	79
MAN >					Manual mode	
	MAN1		Auto		Manual mode 1	88
	MAN2		Auto		Manual mode 2	88
	MAN3		Auto		Manual mode 3	88
	MAN4		Auto		Manual mode 4	88
BLPR >			OFF		Blocking protection	88
OTDIS >			OFF		Thermal disinfection option	89
OPARR >			OFF		Parallel relay option	90
OHQM >			OFF		Energy metering option	90
GFDS >			OFF		Registration Grundfos sensors	90
PRS* >			OFF		Pressure monitoring option	92
DATE >					Enter date	92
LANG >			En		Language	93
UNIT >			°F		Unit	92
OSDC >					SD card option	93
CODE			0000		User code	96
RESET			OFF		Factory setting	

* This channel is only available if the Grundfos sensors have been registered in the **GFDS** channel.

** are blocked against each other

System 17

2-tank solar system with pump logic and heat exchange control

The controller compares the temperature at sensor S1 to the temperatures at sensors S2 and S4. If the measured temperature differences are higher than the adjusted switch-on temperature differences, the pump (R1 and R2) will be activated and the corresponding tank will be loaded up to

the adjusted maximum temperature. Tank 1 is loaded with priority.

Heat exchange from tank 1 to tank 2 (R3) is possible with another temperature differential function (S3-heat source/ S4-heat sink).

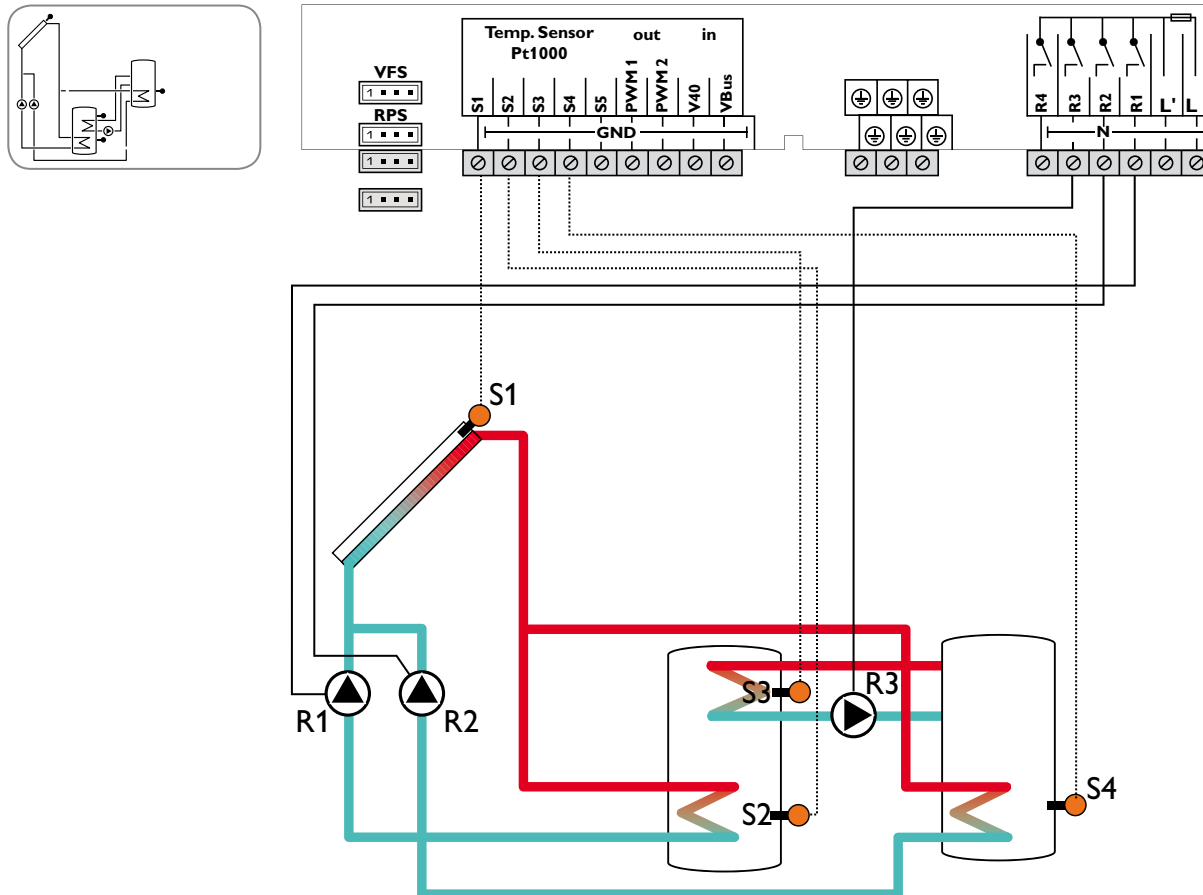

Sensor/Terminal	Designation	Description
S1	TCOL	Temperature collector
S2	TST1B	Temperature tank 1 bottom
S3	TSTT	Temperature tank 1 top
S4	TST2B	Temperature tank 2 bottom
S5		Optional sensor for measurement purposes or options
VFS		
RPS		
V40		

Relay	Description
R1	Solar pump tank 1
R2	Solar pump tank 2
R3	Heat exchange pump
R4	optional: Thermal disinfection Parallel relay Heat dump

Adjustment channels						
Channel	Sub channel 1	Sub channel 2	Factory setting	Change to	Description	Page
ARR			1	17	System	78
LOAD1 >					Loading 1	
	DT1O		12 °R		Switch-on temperature difference 1	78
	DT1F		8 °R		Switch-off temperature difference 1	78
	DT1S		20 °R		Set temperature difference 1	78
	RIS1		4 °R		Rise 1	78
	S1MAX		140 °F		Tank maximum limitation 1	78
	SMXS1		2		Sensor tank max 1	79
LOAD2 >					Loading 2	
	DT2O		12 °R		Switch-on temperature difference 2	78
	DT2F		8 °R		Switch-off temperature difference 2	78
	DT2S		20 °R		Set temperature difference 2	78

Adjustment channels						
Channel	Sub channel 1	Sub channel 2	Factory setting	Change to	Description	Page
	RIS2		4 °R		Rise 2	78
	S2MAX		140 °F		Tank maximum limitation 2	78
	SMXS2		4		Sensor tank max 2	79
	LST2		ON		Loading tank 2	79
COL >					Collector	
	CEM		270 °F		Collector emergency temperature	80
	OCCO**		OFF		Option collector cooling	80
		CMAX	230 °F		Maximum collector temperature	80
	OCMI		OFF		Option collector minimum limitation	80
		CMIN	50 °F		Minimum collector temperature	80
	OTCO		OFF		Option evacuated tube collector function	81
		TCST	07:00		Evacuated tube collector starting time	81
		TCEN	19:00		Evacuated tube collector ending time	81
		TCRU	30 s		Evacuated tube collector runtime	81
		TCIN	30 min		Evacuated tube collector standstill interval	81
	O CFR		OFF		Option collector frost protection	82
		CFR O	40 °F		Antifreeze temperature collector on	82
		CFR F	42 °F		Antifreeze temperature collector off	82
		FRPST	1		Antifreeze tank selection	82
LLOGI >					Loading logic	
	PRIO				Priority logic	82
		PRIO	1		Priority logic	82
		OSTS	OFF		Tank set option	83
		TST1	120 °F		Set tank temperature tank 1	83
		TST2	120 °F		Set tank temperature tank 2	83
		OSE	OFF		Spread function option	83
		DTSE	40		Spread difference	83
	tLB		2 min		Loading break time	82
	tRUN		15 min		Circulation runtime	82
	PSPEE		OFF		Pause speed option	83
	PDELA		OFF		Pump delay option	83
	OOVRU*		OFF		Overrun option	84
COOL >					Cooling functions	
	OSYC**		OFF		System cooling	85
	OSTC		OFF		Tank cooling	85
	OHDP**		OFF		Heat dump	85
DT3 >					Heat exchange	
	DT3O		12 °R		Switch-on difference	86
	DT3F		8 °R		Switch-off difference	86
	DT3S		20 °R		Set difference	86
	RIS3		4 °R		Rise	86
	MAX3O		140 °F		Switch-on temperature (maximum limitation)	86
	MAX3F		136 °F		Switch-off temperature (maximum limitation)	86
	MIN3O		40 °F		Switch-on temperature (minimum limitation)	86
	MIN3F		50 °F		Switch-off temperature (minimum limitation)	86
	S2DT3		4		Reference sensor heat sink	87
PUMP >					Pump speed	
	PUMP1		OnOF		Speed variant pump 1	79
	PUMP2		OnOF		Speed variant pump 2	79
	PUMP3		OnOF		Speed variant pump 3	79
MAN >					Manual mode	
	MAN1		Auto		Manual mode 1	88
	MAN2		Auto		Manual mode 2	88
	MAN3		Auto		Manual mode 3	88
	MAN4		Auto		Manual mode 4	88
BLPR >			OFF		Blocking protection	88
OTDIS >			OFF		Thermal disinfection option	89
OPARR >			OFF		Parallel relay option	90
OHQM >			OFF		Energy metering option	90
GFDS >			OFF		Registration Grundfos sensors	90
PRS* >			OFF		Pressure monitoring option	92
DATE >					Enter date	92

Adjustment channels						
Channel	Sub channel 1	Sub channel 2	Factory setting	Change to	Description	Page
LANG >			En		Language	93
UNIT >			°F		Unit	92
OSDC >					SD card option	93
CODE			0000		User code	96
RESET			OFF		Factory setting	
* This channel is only available if the Grundfos sensors have been registered in the GFDS channel.						
** are blocked against each other						

System 18

Solar system with east-/west collectors and heat exchange control

The controller compares the temperatures at the collector sensors S1 and S5 to the tank temperature at sensor S2. If one of the measured temperature differences is higher than the adjusted switch-on temperature differences, the corresponding pump (R1, R2) or

both pumps will be activated and the tank will be loaded. Heat transfer control to an existent tank (R3) can be carried out with another temperature differential function (S3-heat source/S4-heat sink).

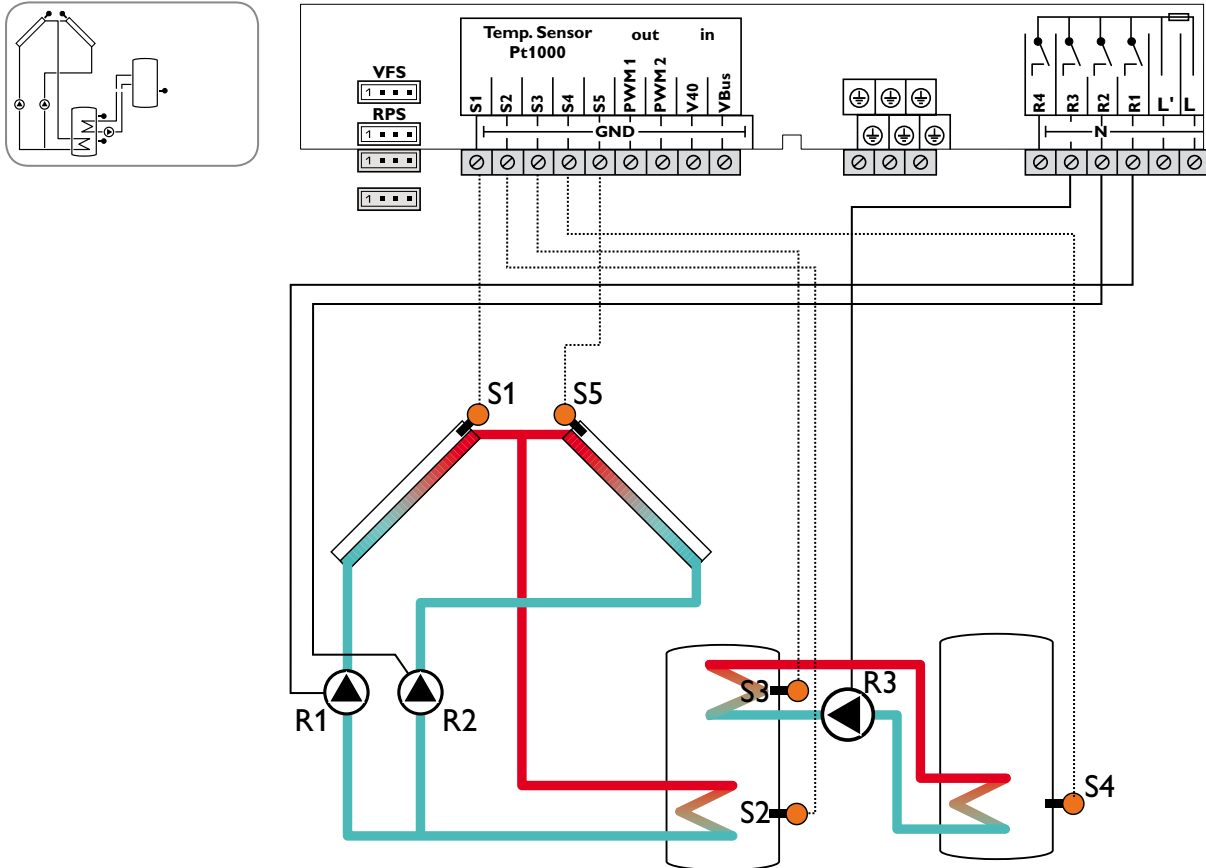

Sensor/Terminal	Designation	Description
S1	TCOL1	Temperature collector 1
S2	TST1B	Temperature tank 1 bottom
S3	TSTT	Temperature tank 1 top
S4	TST2B	Temperature tank 2 bottom
S5	TCOL2	Temperature collector 2
VFS		Optional sensor for measurement purposes or options
RPS		
V40		

Relay	Description
R1	Solar pump collector 1
R2	Solar pump collector 2
R3	Heat exchange pump
R4	optional: Thermal disinfection Parallel relay Heat dump

Adjustment channels						
Channel	Sub channel 1	Sub channel 2	Factory setting	Change to	Description	Page
ARR			1	18	System	78
LOAD >					Loading	
	DT O		12 °R		Switch-on temperature difference	78
	DT F		8 °R		Switch-off temperature difference	78
	DT S		20 °R		Set temperature difference	78
	RIS		4 °R		Rise	78
	S MAX		140 °F		Tank maximum limitation	78
	SMAXS		2		Sensor tank max	79
COL 1 >					Collector 1	
	CEM1		270 °F		Collector emergency temperature 1	80
	OCCO1**		OFF		Option collector cooling 1	80
		CMAx1	230 °F		Maximum collector temperature 1	80
	Ocm11		OFF		Option collector minimum limitation 1	80

Adjustment channels						
Channel	Sub channel 1	Sub channel 2	Factory setting	Change to	Description	Page
		CMIN1	50 °F		Minimum collector temperature 1	80
	OTCO1		OFF		Option evacuated tube collector function 1	81
		TCST1	07:00		Evacuated tube collector starting time 1	81
		TCEN1	19:00		Evacuated tube collector ending time 1	81
		TCRU1	30 s		Evacuated tube collector runtime 1	81
		TCIN1	30 min		Evacuated tube collector standstill interval 1	81
	OCFR		OFF		Option collector frost protection	81
		CFR O	40 °F		Antifreeze temperature collector on	82
		CFR F	42 °F		Antifreeze temperature collector off	82
COL 2 >					Collector 2	
	CEM2		270 °F		Collector emergency temperature 2	80
	OCCO2**		OFF		Option collector cooling 2	80
		CMAx2	230 °F		Maximum collector temperature 2	80
	OCMI2		OFF		Option collector minimum limitation 2	80
		CMIN2	50 °F		Minimum collector temperature 2	80
	OTCO2		OFF		Option evacuated tube collector function 2	81
		TCST2	07:00		Evacuated tube collector starting time 2	81
		TCEN2	19:00		Evacuated tube collector ending time 2	81
		TCRU2	30 s		Evacuated tube collector runtime 2	81
		TCIN2	30 min		Evacuated tube collector standstill interval 2	81
LLOGI >					Loading logic	
	OOVRU*		OFF		Overrun option	84
COOL >					Cooling functions	
	OSYC**		OFF		System cooling	85
	OSTC		OFF		Tank cooling	85
	OHDP**		OFF		Heat dump	85
DT3 >					Heat exchange	
	DT3O		12 °R		Switch-on difference	86
	DT3F		8 °R		Switch-off difference	86
	DT3S		20 °R		Set difference	86
	RIS3		4 °R		Rise	86
	MAX3O		140 °F		Switch-on temperature (maximum limitation)	86
	MAX3F		136 °F		Switch-off temperature (maximum limitation)	86
	MIN3O		40 °F		Switch-on temperature (minimum limitation)	86
	MIN3F		50 °F		Switch-off temperature (minimum limitation)	86
	S2DT3		4		Reference sensor heat sink	87
PUMP >					Pump speed	
	PUMP1		OnOF		Speed variant pump 1	79
	PUMP2		OnOF		Speed variant pump 2	79
	PUMP3		OnOF		Speed variant pump 3	79
MAN >					Manual mode	
	MAN1		Auto		Manual mode 1	88
	MAN2		Auto		Manual mode 2	88
	MAN3		Auto		Manual mode 3	88
	MAN4		Auto		Manual mode 4	88
BLPR >			OFF		Blocking protection	88
OTDIS >			OFF		Thermal disinfection option	89
OPARR >			OFF		Parallel relay option	90
OHQM >			OFF		Energy metering option	90
GFDS >			OFF		Registration Grundfos sensors	90
PRS* >			OFF		Pressure monitoring option	92
DATE >					Enter date	92
LANG >			En		Language	93
UNIT >			°F		Unit	92
OSDC >					SD card option	93
CODE			0000		User code	96
RESET			OFF		Factory setting	

* This channel is only available if the Grundfos sensors have been registered in the **GFDS** channel.

** are blocked against each other

System 19

Solar system with east-/west collectors and thermostatic backup heating

The controller compares the temperatures at the collector sensors S1 and S5 to the tank temperature at sensor S2. If one of the measured temperature differences is higher than the adjusted switch-on temperature differences, the corre-

sponding pump (R1, R2) or both pumps will be activated and the tank will be loaded. Domestic hot water backup heating (R4) can be carried out with a thermostat function (S3).

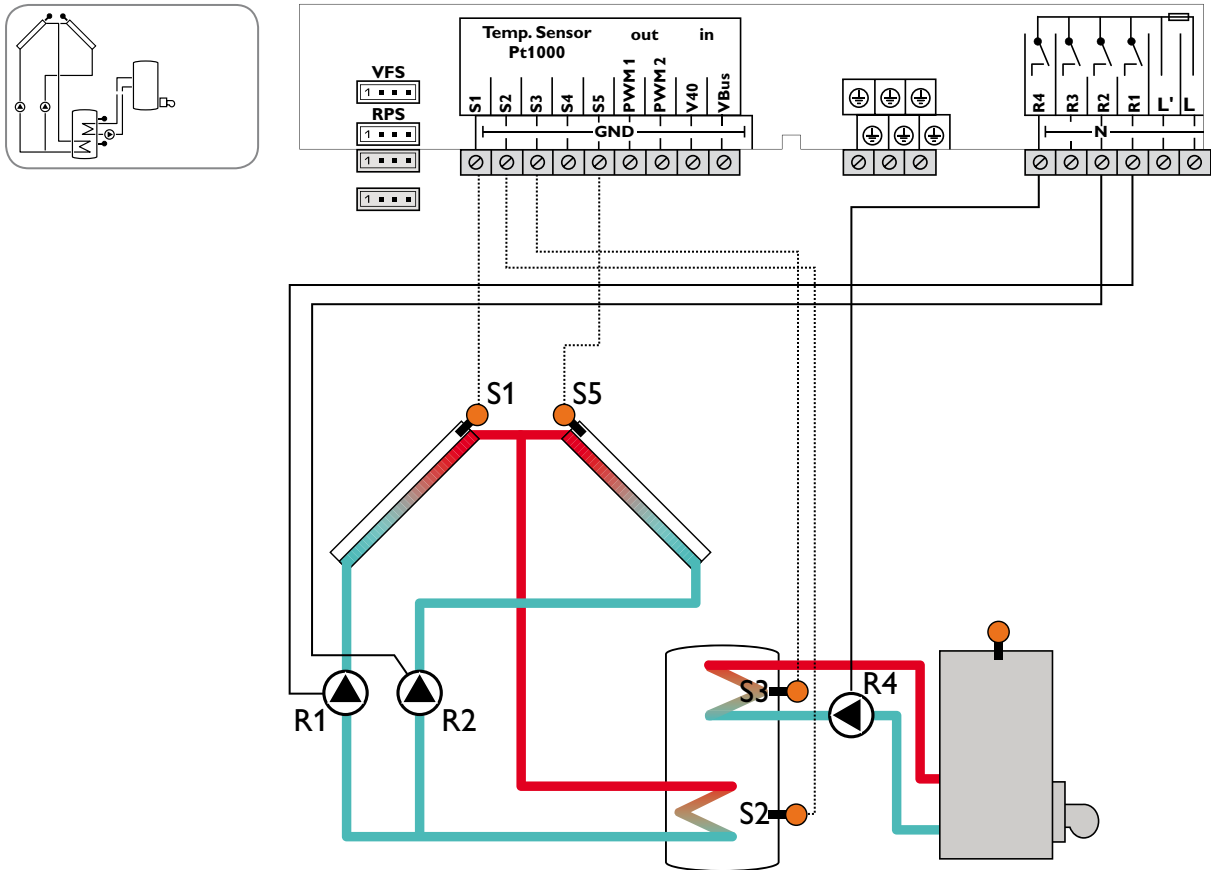

Sensor/Terminal	Designation	Description
S1	TCOL1	Temperature collector 1
S2	TSTB	Temperature tank bottom
S3	TSTT	Temperature tank top
S4		Optional sensor for measurement purposes or options
S5	TCOL2	Temperature collector 2
VFS		Optional sensor for measurement purposes or options
RPS		
V40		

Relay	Description
R1	Solar pump collector 1
R2	Solar pump collector 2
R3	optional: Thermal disinfection Parallel relay
R4	Heat dump Backup heating/tank loading pump

Adjustment channels						
Channel	Sub channel 1	Sub channel 2	Factory setting	Change to	Description	Page
ARR			1	19	System	78
LOAD >					Loading	
	DT O		12 °R		Switch-on temperature difference	78
	DT F		8 °R		Switch-off temperature difference	78
	DT S		20 °R		Set temperature difference	78
	RIS		4 °R		Rise	78
	S MAX		140 °F		Tank maximum limitation	78
	S MAXS		2		Sensor tank max	79
COL 1 >					Collector 1	
	CEM1		270 °F		Collector emergency temperature 1	80
	OCCO1**		OFF		Option collector cooling 1	80
		C MAX1	230 °F		Maximum collector temperature 1	80
	O CM11		OFF		Option collector minimum limitation 1	80

Adjustment channels						
Channel	Sub channel 1	Sub channel 2	Factory setting	Change to	Description	Page
		CMIN1	50 °F		Minimum collector temperature 1	80
	OTCO1		OFF		Option evacuated tube collector function 1	81
		TCST1	07:00		Evacuated tube collector starting time 1	81
		TCEN1	19:00		Evacuated tube collector ending time 1	81
		TCRU1	30 s		Evacuated tube collector runtime 1	81
		TCIN1	30 min		Evacuated tube collector standstill interval 1	81
	OCFR		OFF		Option collector frost protection	81
		CFR O	40 °F		Antifreeze temperature collector on	82
		CFR F	42 °F		Antifreeze temperature collector off	82
COL 2 >					Collector 2	
	CEM2		270 °F		Collector emergency temperature 2	80
	OCCO2**		OFF		Option collector cooling 2	80
		CMAX2	230 °F		Maximum collector temperature 2	80
	OCSI2		OFF		Option collector minimum limitation 2	80
		CMIN2	50 °F		Minimum collector temperature 2	80
	OTCO2		OFF		Option evacuated tube collector function 2	81
		TCST2	07:00		Evacuated tube collector starting time 2	81
		TCEN2	19:00		Evacuated tube collector ending time 2	81
		TCRU2	30 s		Evacuated tube collector runtime 2	81
		TCIN2	30 min		Evacuated tube collector standstill interval 2	81
LLOGI >					Loading logic	
	OOVRU*		OFF		Overrun option	84
COOL >					Cooling functions	
	OSYC**		OFF		System cooling	85
	OSTC		OFF		Tank cooling	85
	OHDP**		OFF		Heat dump	85
AH >					Backup heating option	
	AH O		110 °F		Backup heating switch-on temperature	87
	AH F		120 °F		Backup heating switch-off temperature	87
	t1O		06:00		Switch-on time 1	88
	t1F		22:00		Switch-off time 1	88
	t2O		00:00		Switch-on time 2	88
	t2F		00:00		Switch-off time 2	88
	t3O		00:00		Switch-on time 3	88
	t3F		00:00		Switch-off time 3	88
PUMP >					Pump speed	
	PUMP1		OnOF		Speed variant pump 1	79
	PUMP2		OnOF		Speed variant pump 2	79
	PUMP3		OnOF		Speed variant pump 3	79
MAN >					Manual mode	
	MAN1		Auto		Manual mode 1	88
	MAN2		Auto		Manual mode 2	88
	MAN3		Auto		Manual mode 3	88
	MAN4		Auto		Manual mode 4	88
BLPR >			OFF		Blocking protection	88
OTDIS >			OFF		Thermal disinfection option	89
OPARR >			OFF		Parallel relay option	90
OHQM >			OFF		Energy metering option	90
GFDS >			OFF		Registration Grundfos sensors	90
PRS* >			OFF		Pressure monitoring option	92
DATE >					Enter date	92
LANG >			En		Language	93
UNIT >			°F		Unit	92
OSDC >					SD card option	93
CODE >			0000		User code	96
RESET			OFF		Factory setting	

* This channel is only available if the Grundfos sensors have been registered in the **GFDS** channel.

** are blocked against each other

System 20

Solar system with east-/west collectors, thermostatic backup heating and return preheating

The controller compares the temperatures at the collector sensors S1 and S5 to the tank temperature at sensor S2. If one of the measured temperature differences is higher than the adjusted switch-on temperature differences, the corresponding pump (R1, R2) or both pumps will be activated and the tank will be loaded.

With another temperature differential function (S3-heat source/S4-heat sink) heating circuit return preheating (heating circuit backup) is possible with another valve (R3). Domestic hot water backup heating (R4) can be carried out with a thermostat function (S3).

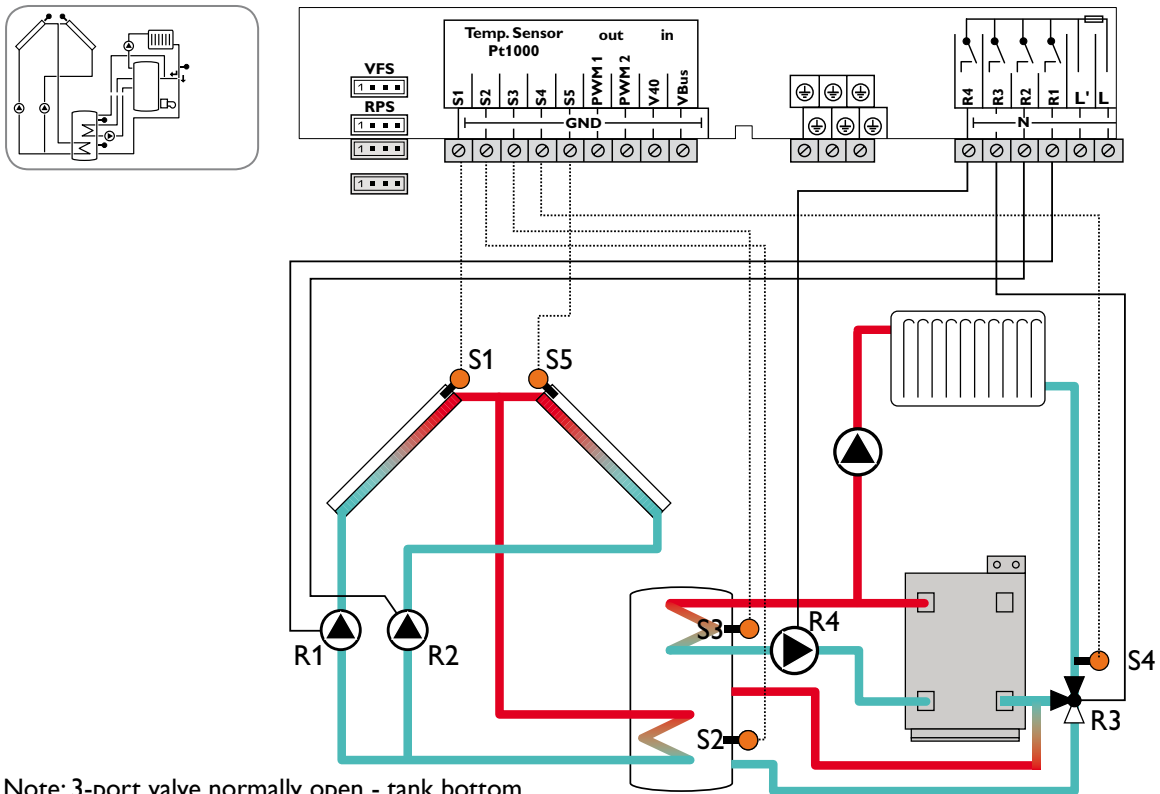

Note: 3-port valve normally open - tank bottom

Sensor/Terminal	Designation	Description
S1	TCOL1	Temperature collector 1
S2	TSTB	Temperature tank bottom
S3	TSTT/TSTR	Temperature tank top/ Temp. tank return preheating
S4	TRET	Temperature - return
S5	TCOL2	Temperature collector 2
VFS		Optional sensor for measurement purposes or options
RPS		
V40		

Relay	Description
R1	Solar pump collector 1
R2	Solar pump collector 2
R3	Return preheating
R4	Backup heating/tank loading pump

Adjustment channels						
Channel	Sub channel 1	Sub channel 2	Factory setting	Change to	Description	Page
ARR			1	20	System Loading	78
LOAD >						
	DT O		12 °R		Switch-on temperature difference	78
	DT F		8 °R		Switch-off temperature difference	78
	DT S		20 °R		Set temperature difference	78
	RIS		4 °R		Rise	78
	S MAX		140 °F		Tank maximum limitation	78
	S MAXS		2		Sensor tank max	79
COL 1 >					Collector 1	
	CEM1		270 °F		Collector emergency temperature 1	80
	OCCO1**		OFF		Option collector cooling 1	80
		C MAX1	230 °F		Maximum collector temperature 1	80
	O CMI1		OFF		Option collector minimum limitation 1	80

Adjustment channels						
Channel	Sub channel 1	Sub channel 2	Factory setting	Change to	Description	Page
		CMIN1	50 °F		Minimum collector temperature 1	80
	OTCO1		OFF		Option evacuated tube collector function 1	81
		TCST1	07:00		Evacuated tube collector starting time 1	81
		TCEN1	19:00		Evacuated tube collector ending time 1	81
		TCRU1	30 s		Evacuated tube collector runtime 1	81
		TCIN1	30 min		Evacuated tube collector standstill interval 1	81
	OCFR		OFF		Option collector frost protection	81
		CFR O	40 °F		Antifreeze temperature collector on	82
		CFR F	42 °F		Antifreeze temperature collector off	82
		FRPST	1		Antifreeze tank selection	82
COL 2 >					Collector 2	
	CEM2		270 °F		Collector emergency temperature 2	80
	OCCO2**		OFF		Option collector cooling 2	80
		CMAX2	230 °F		Maximum collector temperature 2	80
	OCMI2		OFF		Option collector minimum limitation 2	80
		CMIN2	50 °F		Minimum collector temperature 2	80
	OTCO2		OFF		Option evacuated tube collector function 2	81
		TCST2	07:00		Evacuated tube collector starting time 2	81
		TCEN2	19:00		Evacuated tube collector ending time 2	81
		TCRU2	30 s		Evacuated tube collector runtime 2	81
		TCIN2	30 min		Evacuated tube collector standstill interval 2	81
LLOGI >					Loading logic	
	OOVRU*		OFF		Overrun option	84
COOL >					Cooling functions	
	OSYC**		OFF		System cooling	85
	OSTC		OFF		Tank cooling	85
	OHDP**		OFF		Heat dump	85
DT3 >					Return preheating	
	DT3O		12 °R		Switch-on difference	86
	DT3F		8 °R		Switch-off difference	86
	S2DT3		3		Reference sensor heat source	87
AH >					Backup heating option	
	AH O		110 °F		Backup heating switch-on temperature	87
	AH F		120 °F		Backup heating switch-off temperature	87
	t1O		06:00		Switch-on time 1	88
	t1F		22:00		Switch-off time 1	88
	t2O		00:00		Switch-on time 2	88
	t2F		00:00		Switch-off time 2	88
	t3O		00:00		Switch-on time 3	88
	t3F		00:00		Switch-off time 3	88
PUMP >					Pump speed	
	PUMP1		OnOF		Speed variant pump 1	79
	PUMP2		OnOF		Speed variant pump 2	79
	PUMP3		OnOF		Speed variant pump 3	79
MAN >					Manual mode	
	MAN1		Auto		Manual mode 1	88
	MAN2		Auto		Manual mode 2	88
	MAN3		Auto		Manual mode 3	88
	MAN4		Auto		Manual mode 4	88
BLPR >			OFF		Blocking protection	88
OTDIS >			OFF		Thermal disinfection option	89
OPARR >			OFF		Parallel relay option	90
OHQM >			OFF		Energy metering option	90
GFDS >			OFF		Registration Grundfos sensors	90
PRS* >			OFF		Pressure monitoring option	92
DATE >					Enter date	92
LANG >			En		Language	93
UNIT >			°F		Unit	92
OSDC >					SD card option	93
CODE >			0000		User code	96
RESET			OFF		Factory setting	

* This channel is only available if the Grundfos sensors have been registered in the **GFDS** channel.

** are blocked against each other

System 21

Solar system with east-/west collectors and heating circuit return preheating

The controller compares the temperatures at the collector sensors S1 and S5 to the tank temperature at sensor S2. If one of the measured temperature differences is higher than the adjusted switch-on temperature differences, the corresponding pump (R1, R2) or both pumps will be activated and

the tank will be loaded.

With another temperature differential function (S3-heat source/S4-heat sink) heating circuit return preheating (heating circuit backup) is possible with another valve (R3).

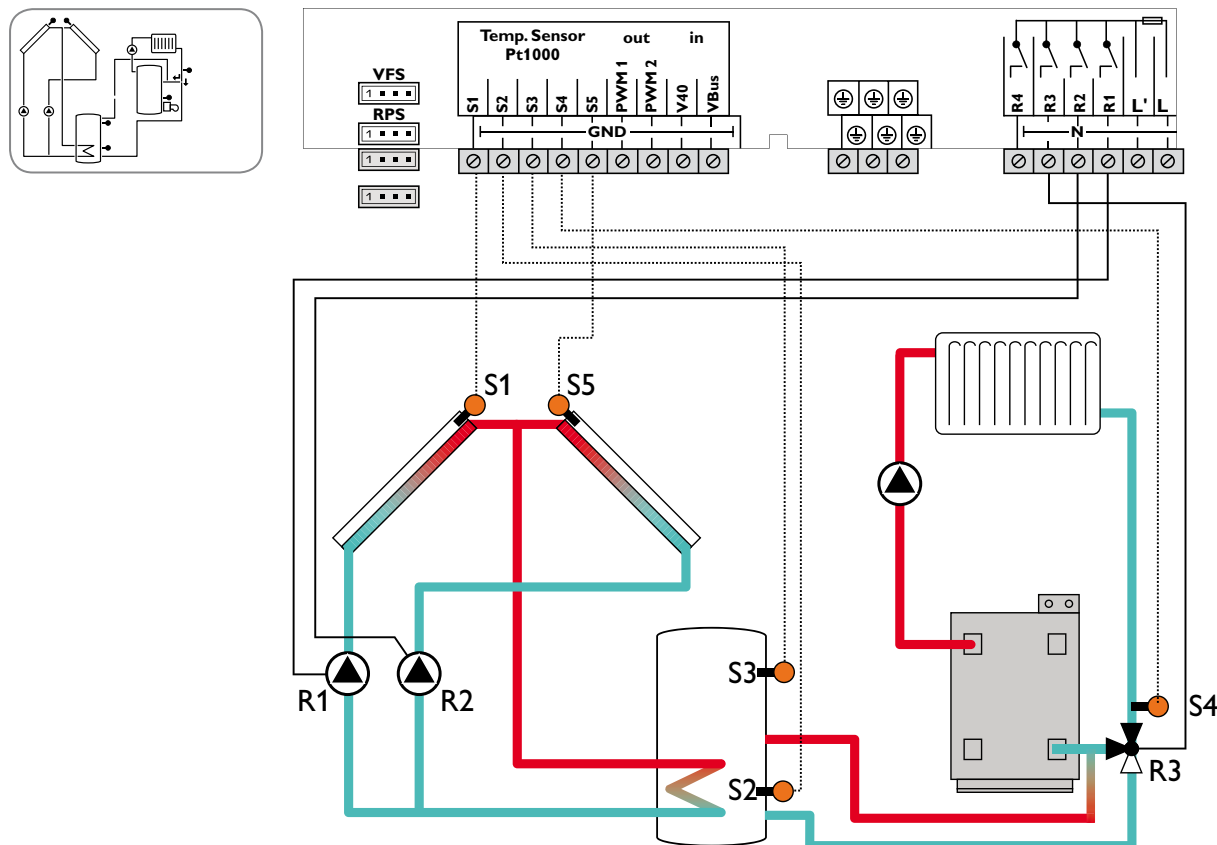

Sensor/Terminal	Designation	Description
S1	TCOL1	Temperature collector 1
S2	TSTB	Temperature tank bottom
S3	TSTT	Temperature tank top
S4	TRET	Temperature - return
S5	TCOL2	Temperature collector 2
VFS		Optional sensor for measurement purposes or options
RPS		
V40		

Adjustment channels						
Channel	Sub channel 1	Sub channel 2	Factory setting	Change to	Description	Page
ARR			1	21	System	78
LOAD >					Loading	
	DT O		12 °R		Switch-on temperature difference	78
	DT F		8 °R		Switch-off temperature difference	78
	DT S		20 °R		Set temperature difference	78
	RIS		4 °R		Rise	78
	S MAX		140 °F		Tank maximum limitation	78
	S MAXS		2		Sensor tank max	79
COL 1 >					Collector 1	
	CEM1		270 °F		Collector emergency temperature 1	80
	OCCO1**		OFF		Option collector cooling 1	80
		C MAX1	230 °F		Maximum collector temperature 1	80
	O CMI1		OFF		Option collector minimum limitation 1	80
		C MIN1	50 °F		Minimum collector temperature 1	80

Adjustment channels						
Channel	Sub channel 1	Sub channel 2	Factory setting	Change to	Description	Page
	OTCO1		OFF		Option evacuated tube collector function 1	81
		TCST1	07:00		Evacuated tube collector starting time 1	81
		TCEN1	19:00		Evacuated tube collector ending time 1	81
		TCRU1	30 s		Evacuated tube collector runtime 1	81
		TCIN1	30 min		Evacuated tube collector standstill interval 1	81
	OCFR		OFF		Option collector frost protection	81
		CFR O	40 °F		Antifreeze temperature collector on	82
		CFR F	42 °F		Antifreeze temperature collector off	82
COL 2 >					Collector 2	
	CEM2		270 °F		Collector emergency temperature 2	80
	OCCO2**		OFF		Option collector cooling 2	80
		CMAX2	230 °F		Maximum collector temperature 2	80
	OCSI2		OFF		Option collector minimum limitation 2	80
		CMIN2	50 °F		Minimum collector temperature 2	80
	OTCO2		OFF		Option evacuated tube collector function 2	81
		TCST2	07:00		Evacuated tube collector starting time 2	81
		TCEN2	19:00		Evacuated tube collector ending time 2	81
		TCRU2	30 s		Evacuated tube collector runtime 2	81
		TCIN2	30 min		Evacuated tube collector standstill interval 2	81
LLOGI >					Loading logic	
	OOVRU*		OFF		Overrun option	84
COOL >					Cooling functions	
	OSYC**		OFF		System cooling	85
	OSTC		OFF		Tank cooling	85
	OHDP**		OFF		Heat dump	85
DT3 >					Return preheating	
	DT3O		12 °R		Switch-on difference	86
	DT3F		8 °R		Switch-off difference	86
	S2DT3		3		Reference sensor heat source	87
PUMP >					Pump speed	
	PUMP1		OnOF		Speed variant pump 1	79
	PUMP2		OnOF		Speed variant pump 2	79
	PUMP3		OnOF		Speed variant pump 3	79
MAN >					Manual mode	
	MAN1		Auto		Manual mode 1	88
	MAN2		Auto		Manual mode 2	88
	MAN3		Auto		Manual mode 3	88
	MAN4		Auto		Manual mode 4	88
BLPR >			OFF		Blocking protection	88
OTDIS >			OFF		Thermal disinfection option	89
OPARR >			OFF		Parallel relay option	90
OHQM >			OFF		Energy metering option	90
GFDS >			OFF		Registration Grundfos sensors	90
PRS* >			OFF		Pressure monitoring option	92
DATE >					Enter date	92
LANG >			En		Language	93
UNIT >			°F		Unit	92
OSDC >					SD card option	93
CODE			0000		User code	96
RESET			OFF		Factory setting	

* This channel is only available if the Grundfos sensors have been registered in the **GFDS** channel.

** are blocked against each other

System 22

Solar system with vertical tank loading and east-/west collectors

The controller compares the temperatures at the collector sensors S1 and S5 to the tank temperatures at the sensors S2 and S3. If one of the measured temperature differences is higher than the adjusted switch-on temperature differences, the corresponding pump (R1, R2) or both pumps will be

activated and the corresponding tank zone will be loaded up to the adjusted maximum temperature via the valve (R3). The priority logic effects prior loading of the upper zone of the tank.

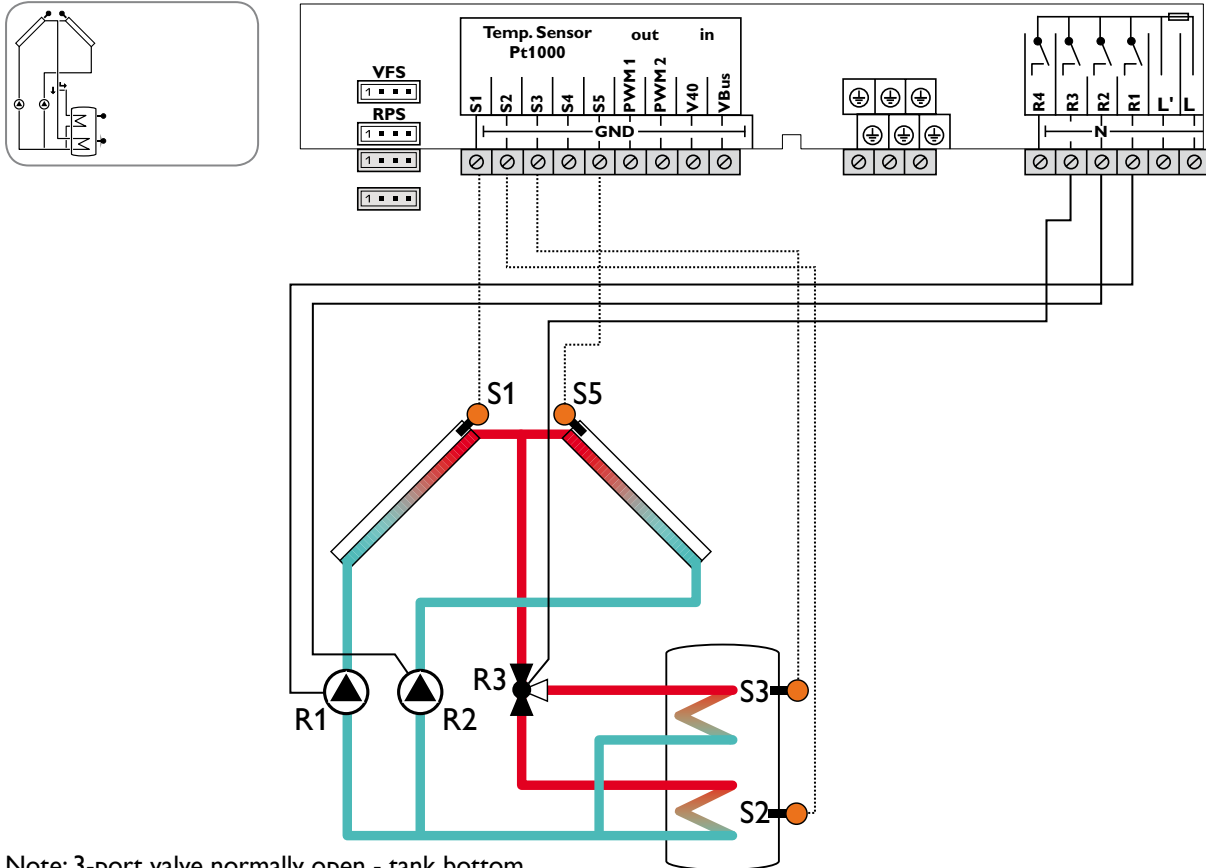

Note: 3-port valve normally open - tank bottom

Sensor/Terminal	Designation	Description
S1	TCOL1	Temperature collector 1
S2	TSTB	Temperature tank bottom
S3	TSTT	Temperature tank top
S4		Optional sensor for measurement purposes or options
S5	TCOL2	Temperature collector 2
VFS		Optional sensor for measurement purposes or options
RPS		
V40		

Relay	Description
R1	Solar pump collector 1
R2	Solar pump collector 2
R3	3-port valve tank top/bottom
R4	optional: Thermal disinfection Parallel relay Heat dump

Adjustment channels						
Channel	Sub channel 1	Sub channel 2	Factory setting	Change to	Description	Page
ARR			1	22	System	78
LOAD1 >					Loading 1	
	DT1O		12 °R		Switch-on temperature difference 1	78
	DT1F		8 °R		Switch-off temperature difference 1	78
	DT1S		20 °R		Set temperature difference 1	78
	RIS1		4 °R		Rise 1	78
	S1MAX		140 °F		Tank maximum limitation 1	78
	SMXS1		2		Sensor tank max 1	79
LOAD2 >					Loading 2	
	DT2O		12 °R		Switch-on temperature difference 2	78
	DT2F		8 °R		Switch-off temperature difference 2	78

Adjustment channels						
Channel	Sub channel 1	Sub channel 2	Factory setting	Change to	Description	Page
	DT2S		20 °R		Set temperature difference 2	78
	RIS2		4 °R		Rise 2	78
	S2MAX		140 °F		Tank maximum limitation 2	78
	LST2		ON		Loading tank 2	79
COL 1 >					Collector 1	
	CEM1		270 °F		Collector emergency temperature 1	80
	OCCO1**		OFF		Option collector cooling 1	80
		CMAX1	230 °F		Maximum collector temperature 1	80
	OCCI1		OFF		Option collector minimum limitation 1	80
		CMIN1	50 °F		Minimum collector temperature 1	80
	OTCO1		OFF		Option evacuated tube collector function 1	81
		TCST1	07:00		Evacuated tube collector starting time 1	81
		TCEN1	19:00		Evacuated tube collector ending time 1	81
		TCRU1	30 s		Evacuated tube collector runtime 1	81
		TCIN1	30 min		Evacuated tube collector standstill interval 1	81
	O CFR		OFF		Option collector frost protection	82
		CFR O	40 °F		Antifreeze temperature collector on	82
		CFR F	42 °F		Antifreeze temperature collector off	82
COL 2 >					Collector 2	
	CEM2		270 °F		Collector emergency temperature 2	80
	OCCO2**		OFF		Option collector cooling 2	80
		CMAX2	230 °F		Maximum collector temperature 2	80
	OCCI2		OFF		Option collector minimum limitation 2	80
		CMIN2	50 °F		Minimum collector temperature 2	80
	OTCO2		OFF		Option evacuated tube collector function 2	81
		TCST2	07:00		Evacuated tube collector starting time 2	81
		TCEN2	19:00		Evacuated tube collector ending time 2	81
		TCRU2	30 s		Evacuated tube collector runtime 2	81
		TCIN2	30 min		Evacuated tube collector standstill interval 2	81
LLOGI >					Loading logic	
	PRIO				Priority logic	82
		PRIO	2		Priority logic	82
		OSTS	OFF		Tank set option	83
		TST1	120 °F		Set tank temperature tank 1	83
		TST2	120 °F		Set tank temperature tank 2	83
		DTSE	70 °R		Spread difference	83
	tLB		2 min		Loading break time	82
	tRUN		15 min		Circulation runtime	82
	PSPEE		OFF		Pause speed option	83
	PDELA		OFF		Pump delay option	83
	OOVRU*		OFF		Overrun option	84
COOL >					Cooling functions	
	OSYC**		OFF		System cooling	85
	OSTC		OFF		Tank cooling	85
	OHDP**		OFF		Heat dump	85
PUMP >					Pump speed	
	PUMP1		OnOF		Speed variant pump 1	79
	PUMP2		OnOF		Speed variant pump 2	79
	PUMP3		OnOF		Speed variant pump 3	79
MAN >					Manual mode	
	MAN1		Auto		Manual mode 1	88
	MAN2		Auto		Manual mode 2	88
	MAN3		Auto		Manual mode 3	88
	MAN4		Auto		Manual mode 4	88
BLPR >			OFF		Blocking protection	88
OTDIS >			OFF		Thermal disinfection option	89
OPARR >			OFF		Parallel relay option	90
OHQM >			OFF		Energy metering option	90
GFDS >			OFF		Registration Grundfos sensors	90
PRS* >			OFF		Pressure monitoring option	92
DATE >					Enter date	92
LANG >			En		Language	93

Adjustment channels						
Channel	Sub channel 1	Sub channel 2	Factory setting	Change to	Description	Page
UNIT >			°F		Unit	92
OSDC >					SD card option	93
CODE			0000		User code	96
RESET			OFF		Factory setting	
* This channel is only available if the Grundfos sensors have been registered in the GFDS channel.						
** are blocked against each other						

System 23

Solar system with east-/west collectors and 2 tanks (valve logic)

The controller compares the temperatures at the collector sensors S1 and S5 to the temperatures at S2 and S4. If one of the measured temperature differences is higher than the adjusted switch-on temperature differences, the correspon-

ding pump (R1, R2) or both pumps will be activated and the corresponding tank will be loaded up to the adjusted maximum temperature via the valve (R3).

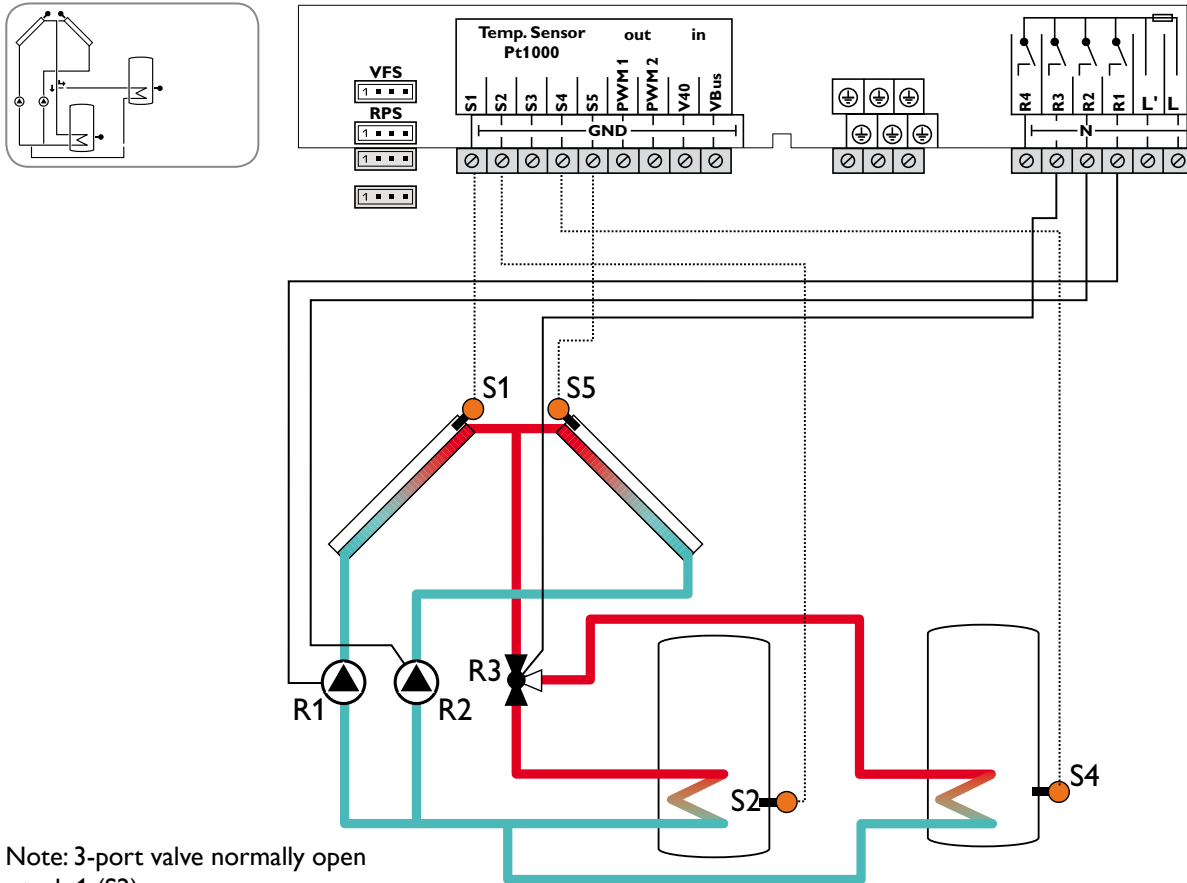

Note: 3-port valve normally open - tank 1 (S2)

Sensor/Terminal	Designation	Description
S1	TCOL1	Temperature collector 1
S2	TST1B	Temperature tank 1 bottom
S3		Optional sensor for measurement purposes or options
S4	TST2B	Temperature tank 2 bottom
S5	TCOL2	Temperature collector 2
VFS		Optional sensor for measurement purposes or options
RPS		
V40		

Relay	Description
R1	Solar pump collector 1
R2	Solar pump collector 2
R3	3-port valve tank 1 / 2
R4	optional: Thermal disinfection Parallel relay Heat dump

Adjustment channels						
Channel	Sub channel 1	Sub channel 2	Factory setting	Change to	Description	Page
ARR			1	23	System	78
LOAD1 >					Loading 1	
	DT1O		12 °R		Switch-on temperature difference 1	78
	DT1F		8 °R		Switch-off temperature difference 1	78
	DT1S		20 °R		Set temperature difference 1	78
	RIS1		4 °R		Rise 1	78
	S1MAX		140 °F		Tank maximum limitation 1	78
	SMXS1		2		Sensor tank max 1	79
LOAD2 >					Loading 2	
	DT2O		12 °R		Switch-on temperature difference 2	78
	DT2F		8 °R		Switch-off temperature difference 2	78
	DT2S		20 °R		Set temperature difference 2	78

Adjustment channels						
Channel	Sub channel 1	Sub channel 2	Factory setting	Change to	Description	Page
	RIS2		4 °R		Rise 2	78
	S2MAX		140 °F		Tank maximum limitation 2	78
	SMXS2		4		Sensor tank max 2	79
	LST2		ON		Loading tank 2	79
COL 1 >					Collector 1	
	CEM1		270 °F		Collector emergency temperature 1	80
	OCCO1**		OFF		Option collector cooling 1	80
		CMAX1	230 °F		Maximum collector temperature 1	80
	OCCI1		OFF		Option collector minimum limitation 1	80
		CMIN1	50 °F		Minimum collector temperature 1	80
	OTCO1		OFF		Option evacuated tube collector function 1	81
		TCST1	07:00		Evacuated tube collector starting time 1	81
		TCEN1	19:00		Evacuated tube collector ending time 1	81
		TCRU1	30 s		Evacuated tube collector runtime 1	81
		TCIN1	30 min		Evacuated tube collector standstill interval 1	81
	O CFR		OFF		Option collector frost protection	82
		CFR O	40 °F		Antifreeze temperature collector on	82
		CFR F	42 °F		Antifreeze temperature collector off	82
		FRPST	1		Antifreeze tank selection	82
COL 2 >					Collector 2	
	CEM2		270 °F		Collector emergency temperature 2	80
	OCCO2**		OFF		Option collector cooling 2	80
		CMAX2	230 °F		Maximum collector temperature 2	80
	OCCI2		OFF		Option collector minimum limitation 2	80
		CMIN2	50 °F		Minimum collector temperature 2	80
	OTCO2		OFF		Option evacuated tube collector function 2	81
		TCST2	07:00		Evacuated tube collector starting time 2	81
		TCEN2	19:00		Evacuated tube collector ending time 2	81
		TCRU2	30 s		Evacuated tube collector runtime 2	81
		TCIN2	30 min		Evacuated tube collector standstill interval 2	81
LLOGI >					Loading logic	
	PRIO				Priority logic	82
		PRIO	1		Priority logic	82
		OSTS	OFF		Tank set option	83
		TST1	120 °F		Set tank temperature tank 1	83
		TST2	120 °F		Set tank temperature tank 2	83
		DTSE	110 °F		Spread difference	83
	tLB		2 min		Loading break time	82
	tRUN		15 min		Circulation runtime	82
	PSPEE		OFF		Pause speed option	83
	PDELA		OFF		Pump delay option	83
	OOVRU*		OFF		Overrun option	84
COOL >					Cooling functions	
	OSYC**		OFF		System cooling	85
	OSTC		OFF		Tank cooling	85
	OHDP**		OFF		Heat dump	85
PUMP >					Pump speed	
	PUMP1		OnOF		Speed variant pump 1	79
	PUMP2		OnOF		Speed variant pump 2	79
	PUMP3		OnOF		Speed variant pump 3	79
MAN >					Manual mode	
	MAN1		Auto		Manual mode 1	88
	MAN2		Auto		Manual mode 2	88
	MAN3		Auto		Manual mode 3	88
	MAN4		Auto		Manual mode 4	88
BLPR >			OFF		Blocking protection	88
OTDIS >			OFF		Thermal disinfection option	89
OPARR >			OFF		Parallel relay option	90
OHQM >			OFF		Energy metering option	90
GFDS >			OFF		Registration Grundfos sensors	90
PRS* >			OFF		Pressure monitoring option	92
DATE >					Enter date	92

Adjustment channels						
Channel	Sub channel 1	Sub channel 2	Factory setting	Change to	Description	Page
LANG >			En		Language	93
UNIT >			°F		Unit	92
OSDC >					SD card option	93
CODE			0000		User code	96
RESET			OFF		Factory setting	
* This channel is only available if the Grundfos sensors have been registered in the GFDS channel.						
** are blocked against each other						

System 24

Solar system with east-/west collectors, vertical tank loading and heat exchange

The controller compares the temperatures at the collector sensors S1 and S5 to the temperatures at S2 and S3. If one of the measured temperature differences is higher than the adjusted switch-on temperature differences, the corresponding pump (R1, R2) or both pumps will be activated and the

corresponding tank zone will be loaded up to the adjusted maximum temperature via the valve (R3). The upper tank zone is loaded with priority. Heat exchange from tank 1 to tank 2 (R4) is possible with another temperature differential function (S3-heat source/S4-heat sink).

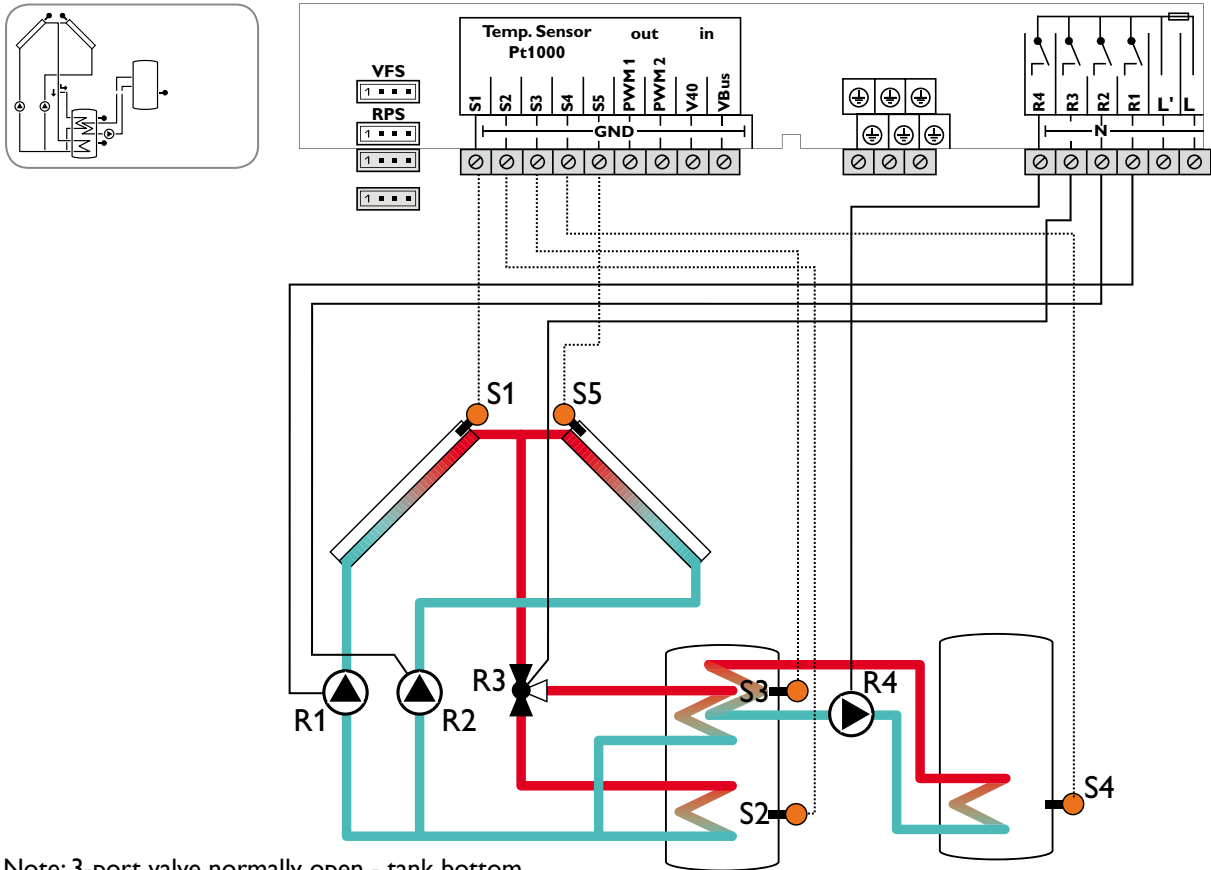

Note: 3-port valve normally open - tank bottom

Sensor/Terminal	Designation	Description
S1	TCOL1	Temperature collector 1
S2	TSTB	Temperature tank bottom
S3	TSTT	Temperature tank top
S4	TST2B	Temperature tank 2 bottom
S5	TCOL2	Temperature collector 2
VFS		Optional sensor for measurement purposes or options
RPS		
V40		

Relay	Description
R1	Solar pump collector 1
R2	Solar pump collector 2
R3	3-port valve tank 1 / 2
R4	Heat exchange pump

Adjustment channels						
Channel	Sub channel 1	Sub channel 2	Factory setting	Change to	Description	Page
ARR			1	24	System	78
LOAD1 >					Loading 1	
	DT1O		12 °R		Switch-on temperature difference 1	78
	DT1F		8 °R		Switch-off temperature difference 1	78
	DT1S		20 °R		Set temperature difference 1	78
	RIS1		4 °R		Rise 1	78
	S1MAX		140 °F		Tank maximum limitation 1	78
	SMXS1		2		Sensor tank max 1	79
LOAD2 >					Loading 2	
	DT2O		12 °R		Switch-on temperature difference 2	78
	DT2F		8 °R		Switch-off temperature difference 2	78
	DT2S		20 °R		Set temperature difference 2	78

Adjustment channels						
Channel	Sub channel 1	Sub channel 2	Factory setting	Change to	Description	Page
	RIS2		4 °R		Rise 2	78
	S2MAX		140 °F		Tank maximum limitation 2	78
	LST2		ON		Loading tank 2	79
COL 1 >					Collector 1	
	CEM1		270 °F		Collector emergency temperature 1	80
	OCCO1**		OFF		Option collector cooling 1	80
		CMAX1	230 °F		Maximum collector temperature 1	80
	OCSI1		OFF		Option collector minimum limitation 1	80
		CMIN1	50 °F		Minimum collector temperature 1	80
	OTCO1		OFF		Option evacuated tube collector function 1	81
		TCST1	07:00		Evacuated tube collector starting time 1	81
		TCEN1	19:00		Evacuated tube collector ending time 1	81
		TCRU1	30 s		Evacuated tube collector runtime 1	81
		TCIN1	30 min		Evacuated tube collector standstill interval 1	81
	O CFR		OFF		Option collector frost protection	82
		CFR O	40 °F		Antifreeze temperature collector on	82
		CFR F	42 °F		Antifreeze temperature collector off	82
COL 2 >					Collector 2	
	CEM2		270 °F		Collector emergency temperature 2	80
	OCCO2**		OFF		Option collector cooling 2	80
		CMAX2	230 °F		Maximum collector temperature 2	80
	OCSI2		OFF		Option collector minimum limitation 2	80
		CMIN2	50 °F		Minimum collector temperature 2	80
	OTCO2		OFF		Option evacuated tube collector function 2	81
		TCST2	07:00		Evacuated tube collector starting time 2	81
		TCEN2	19:00		Evacuated tube collector ending time 2	81
		TCRU2	30 s		Evacuated tube collector runtime 2	81
		TCIN2	30 min		Evacuated tube collector standstill interval 2	81
LLOGI >					Loading logic	
	PRIO				Priority logic	82
		PRIO	2		Priority logic	82
		OSTS	OFF		Tank set option	83
		TST1	120 °F		Set tank temperature tank 1	83
		TST2	120 °F		Set tank temperature tank 2	83
		DTSE	70 °R		Spread difference	83
	tLB		2 min		Loading break time	82
	tRUN		15 min		Circulation runtime	82
	PSPEE		OFF		Pause speed option	83
	PDELA		OFF		Pump delay option	83
	OVRU*		OFF		Overrun option	84
COOL >					Cooling functions	
	OSYC**		OFF		System cooling	85
	OSTC		OFF		Tank cooling	85
	OHDP**		OFF		Heat dump	85
DT3 >					Heat exchange	
	DT3O		12 °R		Switch-on difference	86
	DT3F		8 °R		Switch-off difference	86
	DT3S		20 °R		Set difference	86
	RIS3		4 °R		Rise	86
	MAX3O		140 °F		Switch-on temperature (maximum limitation)	86
	MAX3F		136 °F		Switch-off temperature (maximum limitation)	86
	MIN3O		40 °F		Switch-on temperature (minimum limitation)	86
	MIN3F		50 °F		Switch-off temperature (minimum limitation)	86
	S2DT3		4		Reference sensor heat sink	87
PUMP >					Pump speed	
	PUMP1		OnOF		Speed variant pump 1	79
	PUMP2		OnOF		Speed variant pump 2	79
	PUMP3		OnOF		Speed variant pump 3	79
MAN >					Manual mode	
	MAN1		Auto		Manual mode 1	88
	MAN2		Auto		Manual mode 2	88
	MAN3		Auto		Manual mode 3	88

Adjustment channels						
Channel	Sub channel 1	Sub channel 2	Factory setting	Change to	Description	Page
	MAN4		Auto		Manual mode 4	88
BLPR >			OFF		Blocking protection	88
OTDIS >			OFF		Thermal disinfection option	89
OPARR >			OFF		Parallel relay option	90
OHQM >			OFF		Energy metering option	90
GFDS >			OFF		Registration Grundfos sensors	90
PRS* >			OFF		Pressure monitoring option	92
DATE >					Enter date	92
LANG >			En		Language	93
UNIT >			°F		Unit	92
OSDC >					SD card option	93
CODE			0000		User code	96
RESET			OFF		Factory setting	

* This channel is only available if the Grundfos sensors have been registered in the **GFDS** channel.

** are blocked against each other

System 25

Solar system with east-/west collectors, vertical tank loading and thermostatic backup heating

The controller compares the temperatures at the collector sensors S1 and S5 to the tank temperatures at the sensors S2 and S3. If one of the measured temperature differences is higher than the adjusted switch-on temperature differences, the corresponding pump (R1, R2) or both pumps will be activated and the corresponding tank zone will be loaded

up to the adjusted maximum temperature via the valve (R3). The priority logic effects prior loading of the upper zone of the tank.

Domestic hot water backup heating (R4) can be carried out with a thermostat function (S3).

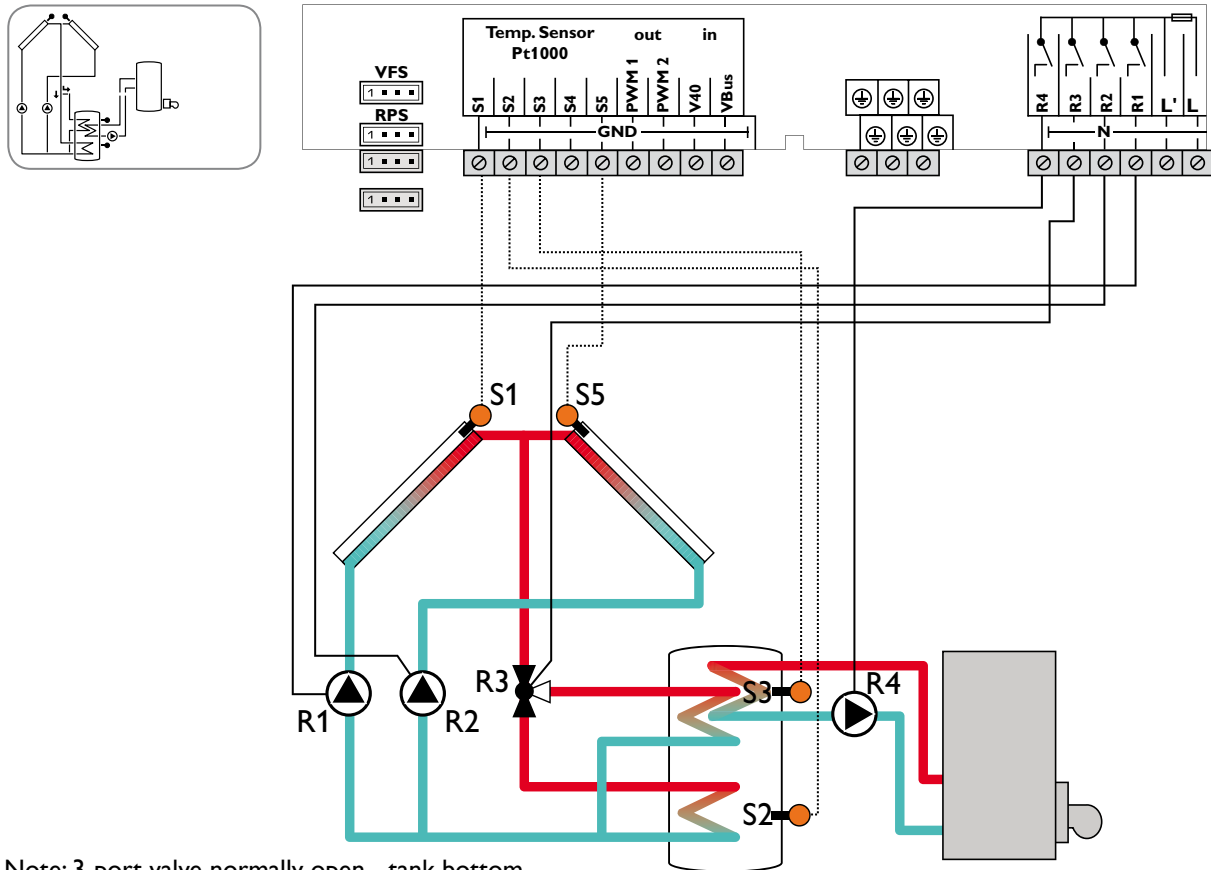

Note: 3-port valve normally open - tank bottom

Sensor/Terminal	Designation	Description
S1	TCOL1	Temperature collector 1
S2	TSTB	Temperature tank bottom
S3	TSTT	Temperature tank top
S4		Optional sensor for measurement purposes or options
S5	TCOL2	Temperature collector 2
VFS		Optional sensor for measurement purposes or options
RPS		
V40		

Relay	Description
R1	Solar pump collector 1
R2	Solar pump collector 2
R3	3-port valve tank top/bottom
R4	Backup heating/tank loading pump

Adjustment channels						
Channel	Sub channel 1	Sub channel 2	Factory setting	Change to	Description	Page
ARR			1	25	System	78
LOAD1 >					Loading 1	
	DT1O		12 °R		Switch-on temperature difference 1	78
	DT1F		8 °R		Switch-off temperature difference 1	78
	DT1S		20 °R		Set temperature difference 1	78
	RIS1		4 °R		Rise 1	78
	S1MAX		140 °F		Tank maximum limitation 1	78
	SMXS1		2		Sensor tank max 1	79
LOAD2 >					Loading 2	
	DT2O		12 °R		Switch-on temperature difference 2	78

Adjustment channels						
Channel	Sub channel 1	Sub channel 2	Factory setting	Change to	Description	Page
	DT2F		8 °R		Switch-off temperature difference 2	78
	DT2S		20 °R		Set temperature difference 2	78
	RIS2		4 °R		Rise 2	78
	S2MAX		140 °F		Tank maximum limitation 2	78
	LST2		ON		Loading tank 2	79
COL 1 >					Collector 1	
	CEM1		270 °F		Collector emergency temperature 1	80
	OCCO1**		OFF		Option collector cooling 1	80
		CMAX1	230 °F		Maximum collector temperature 1	80
	OCSI1		OFF		Option collector minimum limitation 1	80
		CMIN1	50 °F		Minimum collector temperature 1	80
	OTCO1		OFF		Option evacuated tube collector function 1	81
		TCST1	07:00		Evacuated tube collector starting time 1	81
		TCEN1	19:00		Evacuated tube collector ending time 1	81
		TCRU1	30 s		Evacuated tube collector runtime 1	81
		TCIN1	30 min		Evacuated tube collector standstill interval 1	81
	O CFR		OFF		Option collector frost protection	82
		CFR O	40 °F		Antifreeze temperature collector on	82
		CFR F	42 °F		Antifreeze temperature collector off	82
COL 2 >					Collector 2	
	CEM2		270 °F		Collector emergency temperature 2	80
	OCCO2**		OFF		Option collector cooling 2	80
		CMAX2	230 °F		Maximum collector temperature 2	80
	OCSI2		OFF		Option collector minimum limitation 2	80
		CMIN2	50 °F		Minimum collector temperature 2	80
	OTCO2		OFF		Option evacuated tube collector function 2	81
		TCST2	07:00		Evacuated tube collector starting time 2	81
		TCEN2	19:00		Evacuated tube collector ending time 2	81
		TCRU2	30 s		Evacuated tube collector runtime 2	81
		TCIN2	30 min		Evacuated tube collector standstill interval 2	81
LLOGI >					Loading logic	
	PRIO				Priority logic	82
		PRIO	2		Priority logic	82
		OSTS	OFF		Tank set option	83
		TST1	120 °F		Set tank temperature tank 1	83
		TST2	120 °F		Set tank temperature tank 2	83
		DTSE	70 °R		Spread difference	83
	tLB		2 min		Loading break time	82
	tRUN		15 min		Circulation runtime	82
	PSPEE		OFF		Pause speed option	83
	PDELA		OFF		Pump delay option	83
	OOVRU*		OFF		Overrun option	84
COOL >					Cooling functions	
	OSYC**		OFF		System cooling	85
	OSTC		OFF		Tank cooling	85
	OHDP**		OFF		Heat dump	85
AH >					Backup heating option	
	AH O		110 °F		Backup heating switch-on temperature	87
	AH F		120 °F		Backup heating switch-off temperature	87
	t1O		06:00		Switch-on time 1	88
	t1F		22:00		Switch-off time 1	88
	t2O		00:00		Switch-on time 2	88
	t2F		00:00		Switch-off time 2	88
	t3O		00:00		Switch-on time 3	88
	t3F		00:00		Switch-off time 3	88
PUMP >					Pump speed	
	PUMP1		OnOF		Speed variant pump 1	79
	PUMP2		OnOF		Speed variant pump 2	79
	PUMP3		OnOF		Speed variant pump 3	79
MAN >					Manual mode	
	MAN1		Auto		Manual mode 1	88
	MAN2		Auto		Manual mode 2	88

Adjustment channels						
Channel	Sub channel 1	Sub channel 2	Factory setting	Change to	Description	Page
	MAN3		Auto		Manual mode 3	88
	MAN4		Auto		Manual mode 4	88
BLPR >			OFF		Blocking protection	88
OTDIS >			OFF		Thermal disinfection option	89
OPARR >			OFF		Parallel relay option	90
OHQM >			OFF		Energy metering option	90
GFDS >			OFF		Registration Grundfos sensors	90
PRS* >			OFF		Pressure monitoring option	92
DATE>					Enter date	92
LANG >			En		Language	93
UNIT >			°F		Unit	92
OSDC >					SD card option	93
CODE			0000		User code	96
RESET			OFF		Factory setting	

* This channel is only available if the Grundfos sensors have been registered in the **GFDS** channel.

** are blocked against each other

System 26

Solar system with east-/west collectors, vertical tank loading and backup heating with solid fuel boiler

The controller compares the temperatures at the collector sensors S1 and S5 to the tank temperatures at the sensors S2 and S3. If one of the measured temperature differences is higher than the adjusted switch-on temperature differences, the corresponding pump (R1, R2) or both pumps will be activated and the corresponding tank zone will be loaded

up to the adjusted maximum temperature via the valve (R4). The priority logic effects prior loading of the upper zone of the tank.

With another temperature differential function (S4/S3), backup heating of the tank can be carried out with a solid fuel boiler (R3).

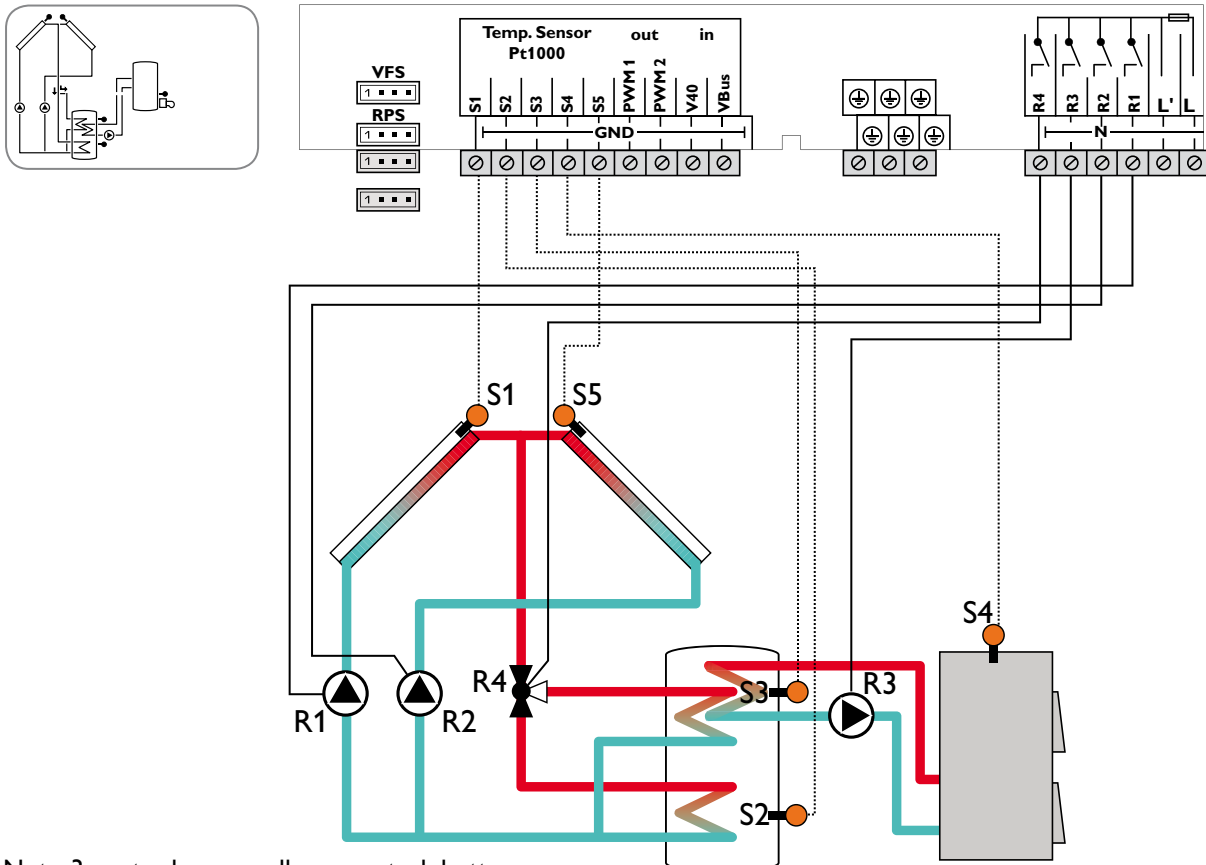

Note: 3-port valve normally open - tank bottom

Sensor/Terminal	Designation	Description
S1	TCOL1	Temperature collector 1
S2	TSTB	Temperature tank bottom
S3	TSTT	Temperature tank top
S4	TSTB	Temperature solid fuel boiler
S5	TCOL2	Temperature collector 2
VFS		Optional sensor for measurement purposes or options
RPS		
V40		

Relay	Description
R1	Solar pump collector 1
R2	Solar pump collector 2
R3	Loading pump solid fuel boiler
R4	3-port valve tank top/bottom

Adjustment channels						
Channel	Sub channel 1	Sub channel 2	Factory setting	Change to	Description	Page
ARR			1	26	System	78
LOAD1 >					Loading 1	
	DT1O		12 °R		Switch-on temperature difference 1	78
	DT1F		8 °R		Switch-off temperature difference 1	78
	DT1S		20 °R		Set temperature difference 1	78
	RIS1		4 °R		Rise 1	78
	S1MAX		140 °F		Tank maximum limitation 1	78
	SMXS1		2		Sensor tank max 1	79
LOAD2 >					Loading 2	
	DT2O		12 °R		Switch-on temperature difference 2	78
	DT2F		8 °R		Switch-off temperature difference 2	78

Adjustment channels						
Channel	Sub channel 1	Sub channel 2	Factory setting	Change to	Description	Page
	DT2S		20 °R		Set temperature difference 2	78
	RIS2		4 °R		Rise 2	78
	S2MAX		140 °F		Tank maximum limitation 2	78
	LST2		ON		Loading tank 2	79
COL 1 >					Collector 1	
	CEM1		270 °F		Collector emergency temperature 1	80
	OCCO1**		OFF		Option collector cooling 1	80
		CMAX1	230 °F		Maximum collector temperature 1	80
	OCCI1		OFF		Option collector minimum limitation 1	80
		CMIN1	50 °F		Minimum collector temperature 1	80
	OTCO1		OFF		Option evacuated tube collector function 1	81
		TCST1	07:00		Evacuated tube collector starting time 1	81
		TCEN1	19:00		Evacuated tube collector ending time 1	81
		TCRU1	30 s		Evacuated tube collector runtime 1	81
		TCIN1	30 min		Evacuated tube collector standstill interval 1	81
	O CFR		OFF		Option collector frost protection	81
		CFR O	40 °F		Antifreeze temperature collector on	82
		CFR F	42 °F		Antifreeze temperature collector off	82
COL 2 >					Collector 2	
	CEM2		270 °F		Collector emergency temperature 2	80
	OCCO2**		OFF		Option collector cooling 2	80
		CMAX2	230 °F		Maximum collector temperature 2	80
	OCCI2		OFF		Option collector minimum limitation 2	80
		CMIN2	50 °F		Minimum collector temperature 2	80
	OTCO2		OFF		Option evacuated tube collector function 2	81
		TCST2	07:00		Evacuated tube collector starting time 2	81
		TCEN2	19:00		Evacuated tube collector ending time 2	81
		TCRU2	30 s		Evacuated tube collector runtime 2	81
		TCIN2	30 min		Evacuated tube collector standstill interval 2	81
LLOGI >					Loading logic	
	PRIO				Priority logic	82
		PRIO	2		Priority logic	82
		OSTS	OFF		Tank set option	83
		TST1	120 °F		Set tank temperature tank 1	83
		TST2	120 °F		Set tank temperature tank 2	83
		DTSE	70 °R		Spread difference	83
	tLB		2 min		Loading break time	82
	tRUN		15 min		Circulation runtime	82
	PSPEE		OFF		Pause speed option	83
	PDELA		OFF		Pump delay option	83
	OOVRU*		OFF		Overrun option	84
COOL >					Cooling functions	
	OSYC**		OFF		System cooling	85
	OSTC		OFF		Tank cooling	85
	OHDP**		OFF		Heat dump	85
DT3 >					Solid fuel boiler	
	DT3O		12 °R		Switch-on difference	86
	DT3F		8 °R		Switch-off difference	86
	DT3S		20 °R		Set difference	86
	RIS3		4 °R		Rise	86
	MAX3O		140 °F		Switch-on temperature (maximum limitation)	86
	MAX3F		136 °F		Switch-off temperature (maximum limitation)	86
	MIN3O		140 °F		Switch-on temperature (minimum limitation)	86
	MIN3F		149 °F		Switch-off temperature (minimum limitation)	86
	S2DT3		3		Reference sensor heat sink	87
PUMP >					Pump speed	
	PUMP1		OnOF		Speed variant pump 1	79
	PUMP2		OnOF		Speed variant pump 2	79
	PUMP3		OnOF		Speed variant pump 3	79
MAN >					Manual mode	
	MAN1		Auto		Manual mode 1	88
	MAN2		Auto		Manual mode 2	88
	MAN3		Auto		Manual mode 3	88

Adjustment channels						
Channel	Sub channel 1	Sub channel 2	Factory setting	Change to	Description	Page
	MAN4		Auto		Manual mode 4	88
BLPR >			OFF		Blocking protection	88
OTDIS >			OFF		Thermal disinfection option	89
OPARR >			OFF		Parallel relay option	90
OHQM >			OFF		Energy metering option	90
GFDS >			OFF		Registration Grundfos sensors	90
PRS* >			OFF		Pressure monitoring option	92
DATE >					Enter date	92
LANG >			En		Language	93
UNIT >			°F		Unit	92
OSDC >					SD card option	93
CODE			0000		User code	96
RESET			OFF		Factory setting	

* This channel is only available if the Grundfos sensors have been registered in the **GFDS** channel.

** are blocked against each other

Electrical connection of a high-efficiency pump (HE pump)

Speed control of a HE pump is possible via a PWM signal. For this purpose, the pump has to be connected to the relay as well as to one of the PWM outputs of the controller (see

page 4). In the PUMP adjustment channel one of the PWM control types has to be selected.

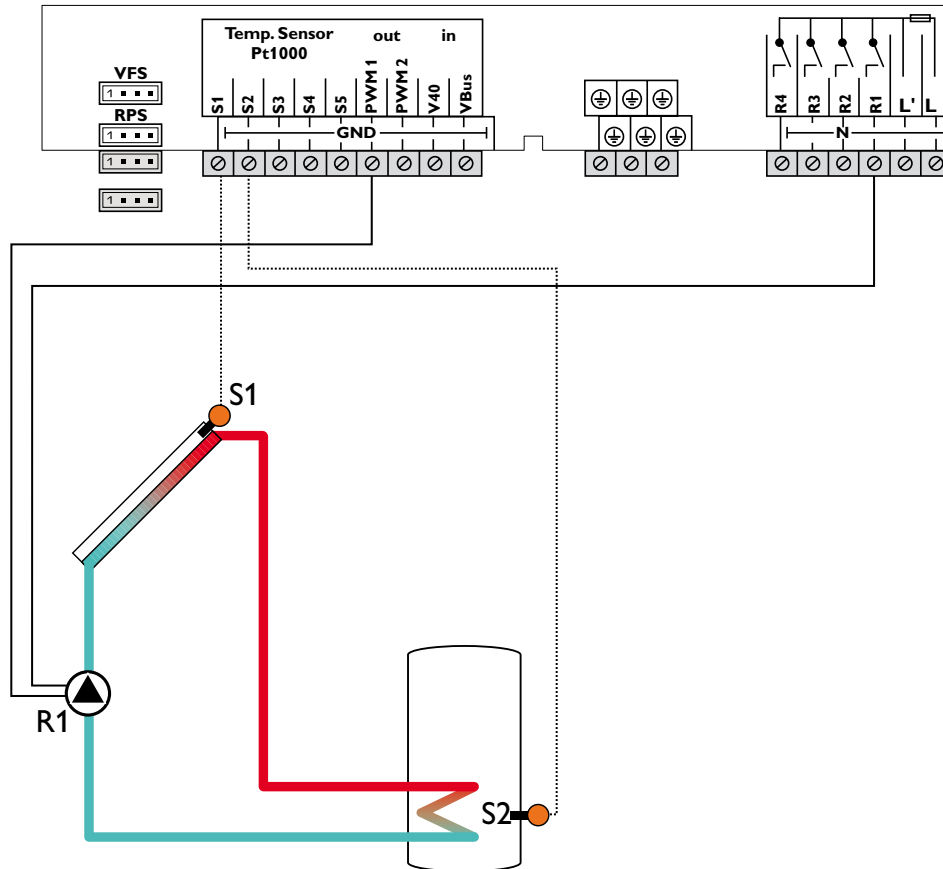

Note:

For more information about pump control, see page 79.





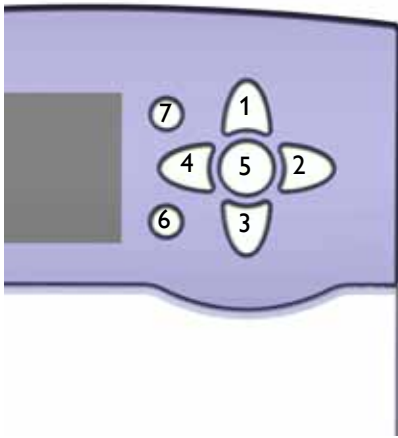

3 Operation and function

3.1 Buttons



3.2 Selecting menu points and adjusting values







The controller is operated via the 7 buttons next to the display. They have the following functions:

- Button  1 - scrolling upwards
- Button  3 - scrolling downwards
- Button  2 - increasing adjustment values
- Button  4 - reducing adjustment values
- Button  5 - confirming
- Button  6 - menu button for changing between the status and the menu level
- Button  7 - escape button for changing into the previous menu

During normal operation of the controller, the display is in the status level.

In order to leave the status level and access the menu level, press button 6.

The display indicates the level with the selectable menus. In order to change the parameters of a menu item, select the menu item and press button 5. The display changes to the adjustment level. The adjustment channels are characterized by the indication **SET**.

- ➔ Select the desired channel by pressing the buttons  1 and  3
- ➔ Confirm the selection with button  5, **SET** flashes (adjustment mode)
- ➔ Adjust the value, the function or the option using the buttons  2 and  4
- ➔ Confirm the selection with button  5, **SET** permanently appears, the adjustment has been saved.

If no button has been pressed within a couple of minutes, the adjustment is cancelled and the previous value is retained.

3.3 Menu structure

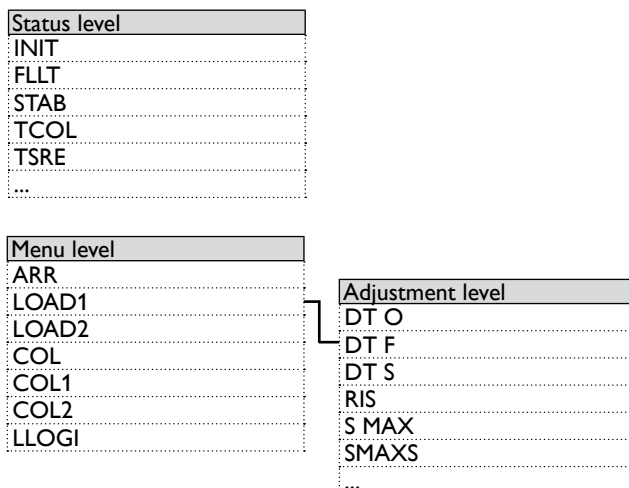

The menu structure of the controller consists of 3 levels: the status level, the menu level and the adjustment level.

The status level consists of different display channels which indicate display values and messages.

The menu level consists of different menu items each of which is divided into sub-menus and adjustment channels. Each of these menu items represents a function or option which can be selected. If a function or option is selected, the controller changes to the adjustment level in which the corresponding parameters of the function or option are available.

In order to activate or deactivate a function, it must be selected in the menu level. The display changes to the adjustment menu in which all adjustments required can be carried out.

During normal operation of the controller, the display is in the status level.

**Note:**

Some of the menu items depend on the selected system and the adjusted options. Therefore, they are only displayed if they are available.

**Note:**

The abstract from the menu structure shown above is for information on the structure of the controller menu and is therefore not complete.

Menu level

If it is possible to jump into a menu, **PUSH** is indicated below the menu item. Use button (5) to access the menu. In order to leave the menu, press button (7).

If an option is deactivated, it will appear in the menu level with the addition **OFF**.

3.4 Indications and system monitoring display

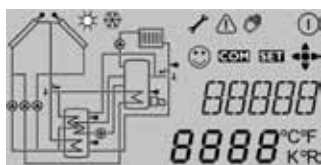

Channel display



Tool bar



The additional symbols in the tool bar indicate the current system state.

The system monitoring display consists of 3 areas: channel display, tool bar and system screen.

The channel display consists of 2 lines. The upper display line is an alphanumeric 16-segment display. In this line, mainly channel names and menu items are displayed. In the lower 7-segment display, channel values and the adjustment parameters are displayed.

Temperatures and temperature differences are indicated with the unit ($^{\circ}\text{C}$ / $^{\circ}\text{F}$ or K / $^{\circ}\text{R}$ respectively).

Symbol	normal	flashing
	Relay active	
	Maximum tank limitation active / maximum tank temperature exceeded	Collector cooling function active System cooling, tank cooling active
	Antifreeze function activated	Collector minimum limitation active Antifreeze function active Collector emergency shutdown
		Sensor fault
		Manual mode active
		Tank emergency shutdown active
		Adjustment channel is being changed (set mode)
		SD card is full
	SD card is being used	
	Indication of the buttons available in the menu item	
	Normal operation	

System screen in the system monitoring display

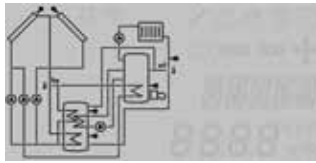

The system selected is indicated in the system monitoring display. It consists of several system component symbols which are – depending on the current status of the system – either flashing, permanently shown or “hidden”.

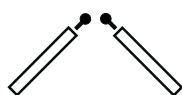
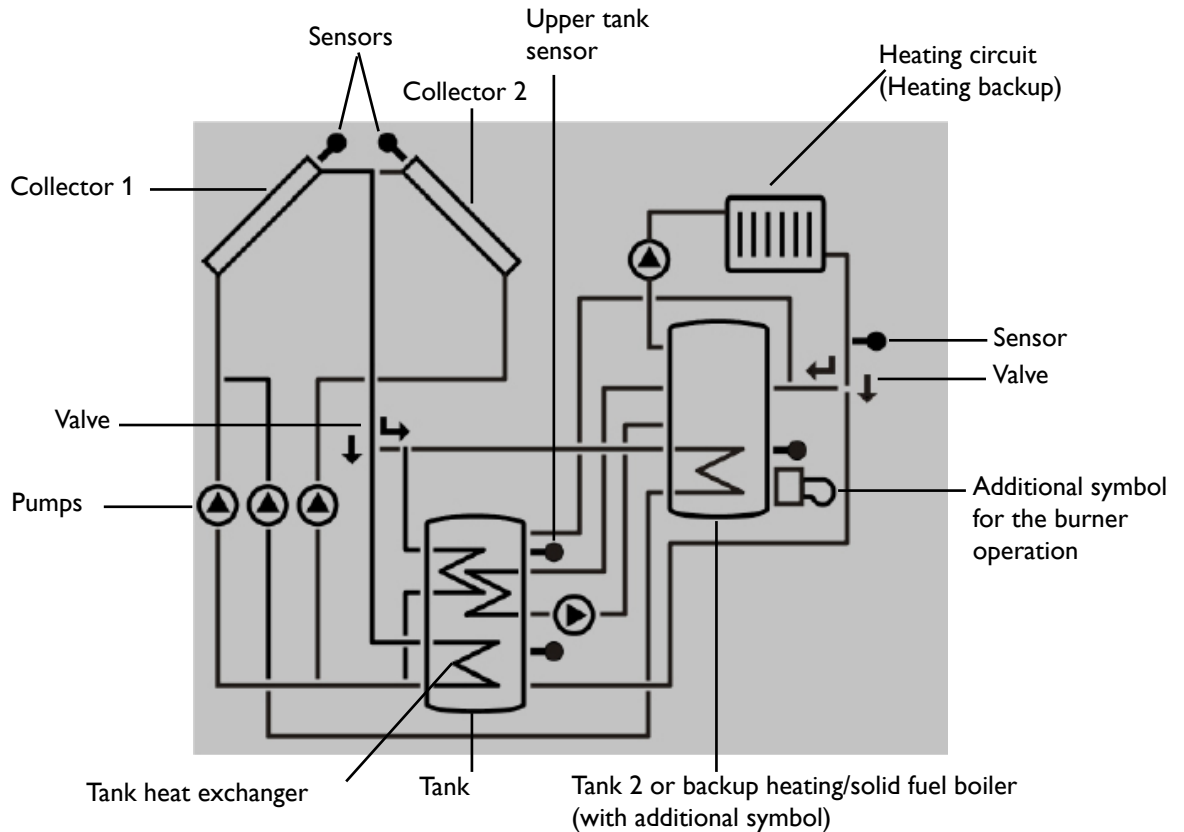

Collectors
with collector sensor

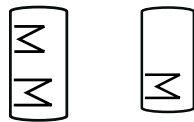

Tank 1 and 2
with heat exchanger

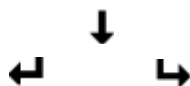

3-port valve
flow direction or current switching position are indicated.



Temperature sensor



Heating circuit
(Heating backup)



Pump

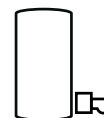

Backup heating with burner symbol

3.5 Further indications

Fault indication

If the controller detects a malfunction, the directional pad flashes red and the symbols of the warning triangle and the wrench are additionally displayed.

Smiley

If the controller operates faultlessly (normal operation), a smiley is displayed.

4 Status menu

During normal operation of the controller, the display is in the status level. This one indicates the measurement values shown in the table.

In addition to the adjustment values, possible error messages are indicated in the status menu (see chap. 98).

Display	Description
BLPR1	Blocking protection R1
BLPR2	Blocking protection R2
BLPR3	Blocking protection R3
INIT	Initialization
FLLT	Filling time
STAB	Stabilization
TCOL	Temperature collector
TCOL1	Temperature collector 1
TCOL2	Temperature collector 2
TSTB	Temperature tank bottom
TST1B	Temperature tank 1 bottom
TSTT	Temperature tank top
TST2B	Temperature tank 2 bottom
TSFL	Temperature solar flow
TSRE	Temperature solar return
TSFB	Temperature solid fuel boiler
TSTR	Temperature tank return preahting
TRET	Temperature - return
S3	Temperature sensor 3
S4	Temperature sensor 4
S5	Temperature sensor 5
n1	Speed relay 1
n2	Speed relay 2
n3	Speed relay 3

Display	Description
n4	Status relay 4
h R1	Operating hours relay 1
h R2	Operating hours relay 2
h R3	Operating hours relay 3
h R4	Operating hours relay 4
L/h	Flow rate Grundfos sensor
BAR	System pressure
TSFL	Temperature solar flow VFS
TSRE	Temperature solar return RPS
TFHQM	Temperature flow energy metering
TRHQM	Temperature return energy metering
L/h	Flow rate V40 or flow gauge
kWh	Heat quantity in kWh
MWh	Heat quantity in MWh
TDIS	Temperature thermal disinfection
CDIS	Countdown thermal disinfection
DDIS	Heating period thermal disinfection
TIME	Time
DATE	Date

* R4 is a standard relay not suitable for speed control. Therefore, its status is indicated with 0 % or 100 % respectively.

5 Initial commissioning

When the hydronic system is filled and ready for operation, connect the controller to the power supply.

The controller runs an initialization phase in which all symbols are indicated in the display. The directional pad flashes red.

Commissioning menu

The commissioning menu consists of the channels described in the following. In order to make an adjustment, push button (5). The set symbol flashes and the adjustment can

1. Language:

→ Adjust the desired menu language.

2. Unit:

→ Adjust the desired unit.

3. Time:

→ Adjust the clock time. First of all adjust the hours, then the minutes.

4. Date:

→ Adjust the date. First of all adjust the year, then the month and then the day.

5. System:

→ Adjust the desired system.

6. Maximum tank temperature:

→ Adjust the maximum tank temperature. In 2-tank systems, the adjustment has to be carried out for **S1MAX** and **S2MAX** as well.

When the controller is commissioned for the first time or when it is reset, it will run a commissioning menu after the initialization phase. The commissioning menu leads the user through the most important adjustment channels needed for operating the system and starts with the indication of the BX version number.

be made. Confirm the adjustment with button (5). Push button (3), the next channel will appear in the display.

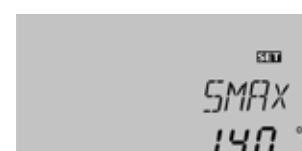
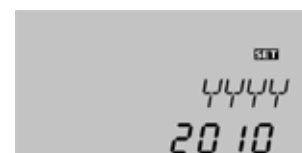
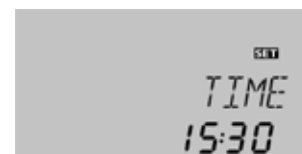

Button navigation

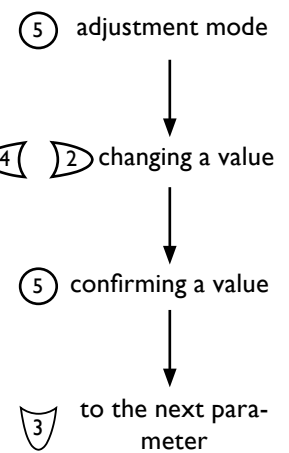

7. Loading tank 2:

→ Switch on or off the “loading tank 2” option.

**Note:**

“Loading tank 2” can only be adjusted if a 2-tank system or vertical tank loading has been selected in the sub channel **ARR**.

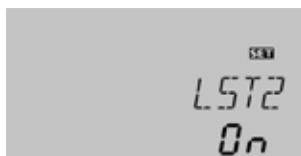
**8. Pump control type:**

→ Adjust the type of pump control for **PUMP1**
Carry out this adjustment for **PUMP2** if needed.

**9. Minimum speed:**

→ Adjust the minimum pump speed for **PUMP1**
In systems with 2 pumps, the adjustment has to be carried out for **PUMP2** as well.

**Note:**

The minimum speed can only be adjusted if pulse control (PULS) or PWM control (A, b, C) has been selected in the sub channel **PUMP1,2**.

10. Maximum speed:

→ Adjust the maximum pump speed for **PUMP1**
In systems with 2 pumps, the adjustment has to be carried out for **PUMP2** as well.

**Note:**

The maximum speed can only be adjusted if pulse control (PULS) or PWM control (A, b, C) has been selected in the sub channel **PUMP1,2**.

11. Range of the flow rate sensor:

→ Adjust the range of the sensor, if the flow rate sensor is connected.

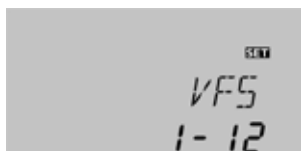
**12. Range of the pressure sensor:**

→ Adjust the range of the sensor, if the pressure sensor is connected.



→ **Complete the commissioning menu by pressing button 5:**

The controller is then ready for operation and normally the factory settings will give close to optimum operation.



6 Functions and options

6.1 Status level

Display of blocking protection time

Blocking protection

BLPR1(2, 3)

Blocking protection active



Note:

The values and adjustment channels shown depend on the selected system, the functions and options and will only be displayed in the expert level.

In order to protect the pumps against blocking after stand-still, the controller is equipped with a blocking protection function. This function switches on the relays every day at 12:00 a.m. for 10 s at 100%.

Display of drainback time periods

Initialization

INIT

Initialization active

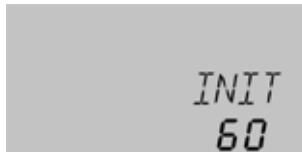

Indicates the time adjusted in tDTO, running backwards.

Filling time

FLLT

Filling time active



Indicates the time adjusted in tFLL, running backwards.

Stabilization

STAB

Stabilization

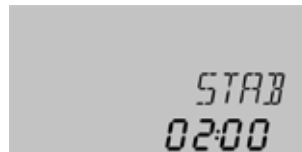

Indicates the time adjusted in tSTB, running backwards.

Display of collector temperatures

TCOL(1, 2)

Collector temperature

Display range: -40...+500 °F

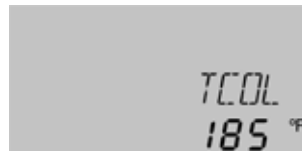

Displays the current collector temperature.

- TCOL : Collector temperature (1-collector system)
- TCOL1 : Collector temperature 1 (2-collector system)
- TCOL2 : Collector temperature 2 (2-collector system)

Display of tank temperatures

TST (1, 2)B, TST (1)T

Tank temperatures

Display range : -40...+500 °F

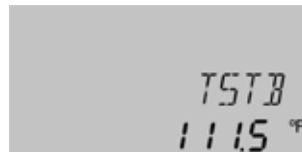

Displays the current tank temperature.

- TSTB : Tank temperature bottom
 - TSTT : Tank temperature top
- in 2-tank systems (only if available):
- TST1T : Temperature tank 1 top
 - TST1B : Temperature tank 1 bottom
 - TST2T : Temperature tank 2 top
 - TST2B : Temperature tank 2 bottom

Display of temperatures at S3, S4 and S5

S3, S4, S5

Sensor temperatures

Display range : -40...+500 °F

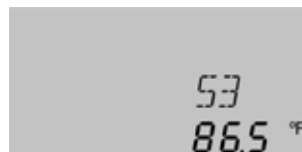

Indicates the current temperature at the corresponding additional sensor (without control function).

- S3 : Temperature sensor 3
- S4 : Temperature sensor 4
- S5 : Temperature sensor 5



Note:

Only if temperature sensors are connected, will S3, S4 and S5 be displayed.



Note:

In systems with return preheating, S3/S5 is used as the heat source sensor TSTR.

Display of further temperatures

TSFB, TRET, TSTR,
TFHQM, TRHQM,
TSFL(VFS), TSRE (RPS)
Other measured temperatures
Display range: -40...+500 °F

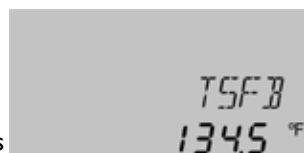

Indicates the current temperature at the corresponding sensor. The display of these temperatures depends on the system selected.

- TSFB : Temperature solid fuel boiler
- TRET : Temperature heating return
- TSTR : Temperature tank return preheating
- TFHQM : Temperature flow (HQM)
- TRHQM : Temperature return (HQM)

Display of flow rate

L/H
Flow rate
Display range: 0 ... 9999 l/h

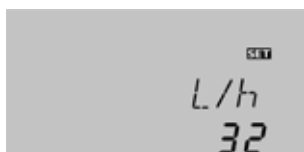

Indicates the measured current flow rate in the solar system. The flow rate value is used for calculating the heat quantity supplied (V40 /VFS).

Display of pressure

BAR
Pressure
Display range: 0 ... 10 bar

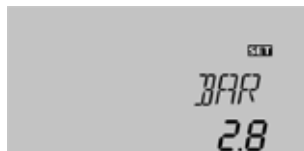

Indicates the current system pressure.



Note:

The pressure will only be indicated if an RPS sensor is used.

Display of speed

M1%, M2%, M3%
Current pump speed
Display range: 30 ... 100%
standard pump;
20 ... 100 % HE pump

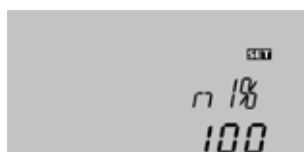

Indicates the current speed of the corresponding pump.

Operating hours counter

HR (1, 2, 3, 4)
Operating hours counter

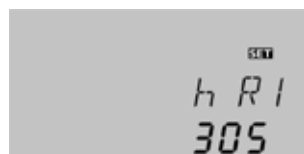

The operating hours counter accumulates the solar operating hours of the relay (h R1 / h R2 / h R3 / h R4). Full hours are displayed.

The accumulated operating hours can be set back to 0. As soon as one operating hours channel is selected, the symbol **SET** is displayed.

→ In order to access the RESET-mode of the counter, press the set button (5).

The display symbol **SET** will flash and the operating hours will be set to 0.

→ Confirm the reset with the set button (5) in order to finish the reset.

In order to interrupt the RESET-process, do not press any button for about 5 s. The display returns to the display mode.

Display of heat quantity

KWh/MWh:

Heat quantity in kWh / MWh

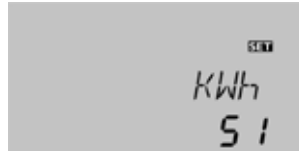

Indicates the heat quantity produced in the system. For this purpose, the energy metering option has to be enabled.

The flow rate as well as the values of the reference sensors S1 (flow) and S4 (return) are used for calculating the heat quantity supplied. It is shown in kWh in the channel **kWh** and in MWh in the channel **MWh**. The overall heat quantity results from the sum of both values.

The accumulated heat quantity can be set back to 0. As soon as one of the display channels of the heat quantity is selected, the symbol **SET** is displayed.

→ In order to access the RESET-mode of the counter, press the set button **(5)** for approx. 2 s.

The display symbol **SET** will flash and the heat quantity will be set to 0.

→ Confirm the reset with the set button in order to finish the reset.

In order to interrupt the RESET process, no button should be pressed for about 5 s. The display returns to the display mode.

Display of monitoring period

CDIS

Countdown of monitoring period

Display range:

0 ... 30:0 ... 24 (dd:hh)

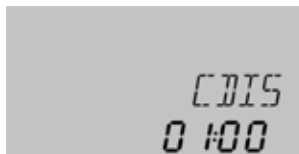

If the thermal disinfection option (**OTDIS**) is activated and the monitoring period is in progress, the remaining time of the monitoring period is displayed as **CDIS** (in hours and minutes), counting backwards.

Display of starting time

SDIS

Starting point

Display range:

0:00 ... 24:00 (time)

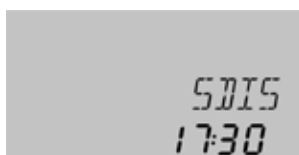

If the thermal disinfection option (**OTDIS**) is activated and starting delay time has been adjusted, the adjusted delay time is displayed (flashing) in this channel.

Display of heating period

DDIS

Heating period

Display range:

0:00 ... 23:59 (hh:mm)

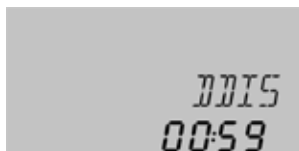

If the thermal disinfection option (**OTDIS**) is activated and the heating period is in progress, the remaining time of the heating period is displayed (in hours and minutes) in this channel, counting backwards.

Display of time

TIME

Time

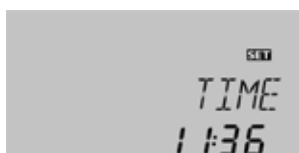

Adjust the current clock time.

6.2 Adjustment channels

Selecting the system

ARR
System
Adjustment range: 1 ... 26
Factory setting: 1



Note:

If the controller is commissioned for the first time, the commissioning menu will start. The subsequent selection of a new system will reset all other adjustments to the factory settings.

Selection of the appropriate system. Each system has pre-programmed options and adjustments which can be activated or changed respectively if necessary. Select the system first (see chap. 3).

ΔT -regulation

LOAD(1, 2) / DT(1, 2) 0
Switch-on temperature difference
Adjustment range: 2.0 ... 90.0 °R
in steps of 1.0 °R
Factory setting: 12.0 °R

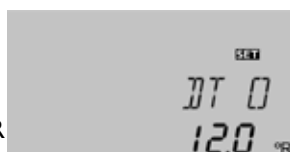

The controller works as a standard differential controller. If the switch-on difference is reached, the pump is activated. When the temperature difference reaches or falls below the adjusted switch-off temperature difference, the respective relay switches off.

LOAD 2) / DT(1, 2) F
Switch-off temperature difference
Adjustment range: 1.0 ... 89.0 °R
in steps of 1.0 °R
Factory setting: 8.0 °R

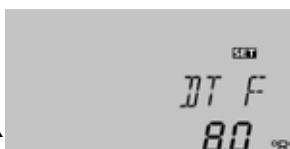

Note:

The switch-on temperature difference is blocked against the switch-off temperature difference by 1 °R. **DT 0** must be at least 1 °R higher than **DT F**. The set temperature difference must be at least 1 °R higher than the switch-on temperature difference.

Speed control

LOAD(1, 2) / DT(1, 2) 5
Set temperature difference
Adjustment range: 3.0...90.0 °R
in steps of 1.0 °R
Factory setting: 20.0 °R



Note:

To enable speed control, the corresponding relay has to be set to "Auto" (adjustment channel **MAN**) and the pump control type has to be set to Puls,A, b, or C (adjustment channel **PUMP**).

LOAD(1, 2) / RIS(1, 2)
Rise
Adjustment range: 2.0 ... 40 °R
in steps of 2 °R
Factory setting: 4 °R



When the switch-on temperature difference is reached, the pump is activated at 100% speed for 10 s. Then, the speed is reduced to the minimum pump speed value.

If the temperature difference reaches the adjusted nominal value (**DT S**), the pump speed increases by one step (10 %). The response of the controller can be adapted via the parameter "Rise". If the difference increases by the adjustable rise value RIS, the pump speed increases by 10 % until the maximum pump speed of 100 % is reached. If, at decreasing temperatures, the temperature difference decreases by the adjustable rise value **RIS**, the pump speed decreases by 10 %.

Maximum tank temperature

LOAD(1, 2) / S(1, 2) MAX
Maximum tank temperature
Adjustment range: 40 ... 200 °F
in steps of 2 °F
Factory setting: 140 °F

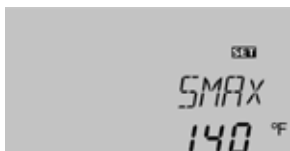

If the tank temperature reaches the adjusted maximum temperature, the tank will no longer be loaded in order to avoid damage caused by overheating. If the maximum tank temperature is exceeded, ☀ is displayed (flashing).

The corresponding reference sensor can be chosen, see "Sensor maximum tank temperature".

Switch-on hysteresis -4K

Sensor maximum tank temperature*LORD0,2) / S0,2)MAXS*

Sensor tank maximum temp.

Adjustment range:

1-tank system: S2, S3

2-tank system: S4, S5

Factory setting:

1-tank system: S2

2-tank system: S4

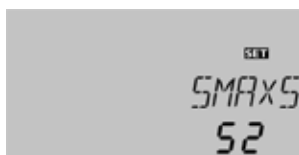

Allocation of the sensor for tank maximum limitation. The maximum limitation always refers to the sensor selected. If S3 is selected, the differential control will be carried out using S1 and S2. The temperature at S2 can exceed the adjusted limit temperature, the system will not switch off. If the value at S3 reaches the limit temperature, the system will be switched off.

**Note:**

In 1-tank systems with sensor S3 as the reference sensor, loading will be switched off if the temperature at S2 or S3 reaches the tank emergency shutdown temperature.

In 2-tank systems, loading will be switched off if the temperature at S4 or S5 reaches the tank emergency shutdown temperature.

Loading tank 2*LORD2 / LST2*

Loading tank 2

Selection: ON / OFF

Factory setting: ON

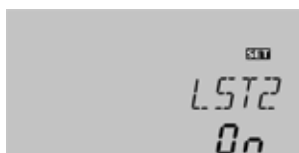

In a 2-tank system, the second tank can be switched off for loading via the parameter **LST2**.

If **LST2** is adjusted to **OFF**, the system runs like a 1-tank system. The representation in the display does not change.

Pump control*PUMP / PUMP1 (2, 3)*

Pump control

Selection: OnOF, Puls, PWM A,

PWM b, PWM C,

Factory setting: OnOF

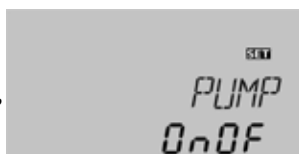

With this parameter, the pump control type can be adjusted. The following types can be selected:

Adjustment for standard pump without speed control

- OnOF (pump on / pump off)

Adjustment for standard pump with speed control

- PULS (pulse packet control via semiconductor relay)

Adjustment for high efficiency pump (HE pump)

- PWMA (Wilo)
- PWM b (Grundfos)
- PWM C (Laing)

**Note:**

For more information about connecting HE pumps, see page 68.

**Note:**

PUMP3 can only be set to OnOf or PULS.

Minimum speed*PUMP1 (2, 3) / n1 (2, 3) LO*

Speed control

Adjustment range: 20 ... 100 %
in steps of 5%

Factory setting: 30 %

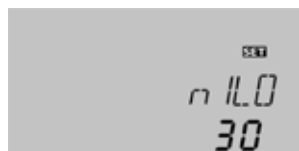

In the adjustment channel **n1(2, 3)LO**, a relative minimum speed for connected pumps can be allocated to the outputs R1, R2 and R3.

**Note:**

When loads which are not speed-controlled (e. g. valves) are used, the value of the corresponding relay (n1, n2, n3) must be set to 100% or the pump control type must be set to OnOF in order to deactivate pump speed control.

Maximum speed*PUMP1 (2, 3) / n1 (2, 3) HI*

Speed control

Adjustment range: 20 ... 100 %
in steps of 5%

Factory setting: 100 %

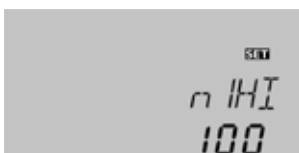

In the adjustment channel **n1(2, 3)HI**, a relative maximum speed for connected pumps can be allocated to the outputs R1, R2 and R3.

**Note:**

When loads which are not speed-controlled (e. g. valves) are used, the value of the corresponding relay (n1, n2, n3) must be set to 100% or the pump control type must be set to OnOF in order to deactivate pump speed control.

Collector emergency shutdown

COL(1,2) / CEM(1,2)

Collector emergency temperature

Adjustment range: 170 ... 390 °F
in steps of 2 °F

Factory setting: 270 °F

Switch-on hysteresis: -10 °R

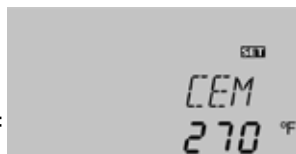

When the collector temperature exceeds the adjusted collector emergency temperature (**CEM / CEM1 / CEM2**), the solar pump (R1 / R2) is switched off in order to protect the system components against overheating (collector emergency shutdown). If the maximum collector temperature is exceeded, Δ is displayed (flashing).



Note:

If the drainback option **ODB** is activated, the adjustment range of the collector emergency temperature is changed to 170 ... 200 °F. Factory setting in that case is 200 °F.

WARNING!



Danger of injury and system damage through pressure surges!

If water is used as a heat transfer medium in a pressure-less system, the water will start boiling at 212 °F

→ If a pressure-less drainback system is used with water as a heat transfer medium, do not adjust the collector temperature limitation **CEM** to more than 200 °F

Collector cooling

COL(1,2) / OCCO(1,2)

Adjustment range ON / OFF
Factory setting: OFF



This function is used for keeping the system temperatures and consequently the thermal load as low as possible.

When the tank temperature exceeds the adjusted maximum tank temperature, the system stagnates. If the collector temperature increases to the adjusted maximum collector temperature, the solar pump is activated until the collector temperature falls below the maximum collector temperature. The tank temperature may then exceed the maximum temperature, but only up to 200 °F (emergency shutdown of the tank).

If the collector cooling is active, \star is displayed (flashing).



Note:

This function is only available, if the system cooling function and the heat dump function are deactivated.

COL(1,2) / OCCO(1,2) /
C MAX(1,2)

Collector maximum temp.

Adjustment range: 150 ... 320 °F
in steps of 2 °F

Factory setting: 230 °F

Switch-on hysteresis: -10 °R

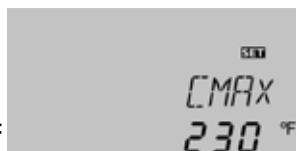

Minimum collector limitation

COL(1,2) / OCCMI(1,2)

Collector minimum temp.

Adjustment range: ON / OFF
Factory setting: OFF



The minimum collector temperature is the minimum switch-on temperature which must be exceeded for the solar pump (R1 / R2) to switch on. The minimum temperature prevents the pump from being switched on too often at low collector temperatures. If the collector temperature falls below the adjusted minimum temperature, \star is displayed (flashing).

COL(1,2) / OCCMI(1,2) /
C MIN(1,2)

Collector minimum temp.

Adjustment range: 50 ... 190 °F
in steps of 2 °F

Factory setting: 50 °F



Evacuated tube collector function

COL / OTCO (1, 2)
Evacuated tube collector
function
Selection: ON / OFF
Factory setting: OFF



*COL / OTCO (1, 2) / TCST
(1, 2)*
Starting time
Adjustment range:
00:00 ... 23:00
Factory setting: 07:00

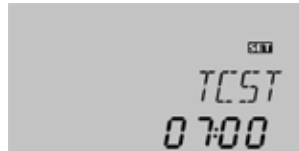

COL / OTCO (1, 2) / TCEN (1, 2)
Ending time
Adjustment range:
00:30 ... 23:30
in steps of 00:30
Factory setting: 19:00

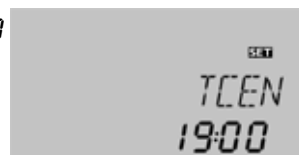

COL / OTCO (1, 2) / TCRU (1, 2)
Runtime
Adjustment range: 30 ... 300 s
in steps of 5 s
Factory setting 30 s

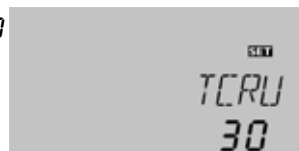

COL / OTCO (1, 2) / TCIN (1, 2)
Standstill interval
Adjustment range: 5 ... 60 min
in steps of 00:01
Factory setting: 30 min

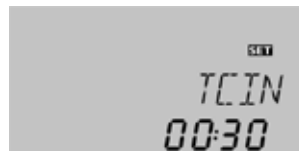

This function helps overcome the non-ideal sensor position with some evacuated tube collectors.

This function operates within an adjusted time frame, beginning at **TCST** and ending at **TCEN**. It activates the collector circuit pump for an adjustable runtime (**TCRU**) between adjustable standstill intervals (**TCIN**) in order to compensate for the delayed temperature measurement.

If the runtime **TCRU** is set to more than ten seconds, the pump will be run at 100 % for the first 10 s of the runtime. For the remaining runtime, the pump will be run at the adjusted minimum speed **nLO**.

If the collector sensor is defective or the collector is blocked, this function is suppressed or switched off.

2-collector systems

In 2-collector systems, the evacuated tube collector function is available for each collector field (**OTCO2**).

If one of the collector fields is being loaded, the heat transfer fluid flows through the inactive field and only the corresponding relay is energized.

Multi-tank systems

If the evacuated tube collector function is activated, the speed of the solar pump will decrease to **nLO** during the loading break time. The solar loading of the subordinate tank will continue.

In 2-collector systems, during the loading break time the collector field which has been active before the loading break time remains active during the loading break time, unless the evacuated tube collector function of the inactive field becomes active.

**Note:**

If the drainback option **ODB** is activated, the evacuated tube collector function **OTCO** will not be available.

Antifreeze function*COL (1) / DCFR*

Antifreeze function

Selection: ON / OFF

Factory setting: OFF

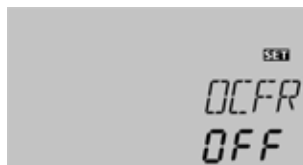
*COL (1) / DCFR / CFR 0*

Antifreeze temperature on

Adjustment range: -40...+46 °F

Factory setting: 40 °F

COL (1) / DCFR / CFR F

Antifreeze temperature off

Adjustment range: -39...+48 °F

Factory setting: 42 °F

COL (1) / DCFR / FRPST

Sensor selection

Selection: 1, 2

Factory setting: 1

in 2-tank systems only

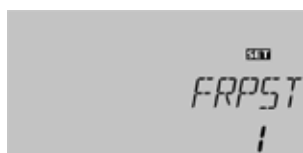
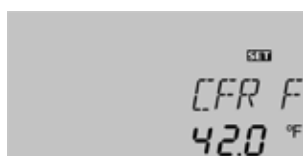
**Priority logic****Note:**

Priority logic can be used in 2-tank systems or systems with vertical tank loading only.

LLOGI / PRIO

Priority logic

Adjustment range:

0, 1, 2, Su1, Su2

Factory setting: 1

Factory setting: 2 (stratified tank)

*LLOGI / TLB*

Loading break time

Adjustment range: 1 ... 30 min

Factory setting: 2 min

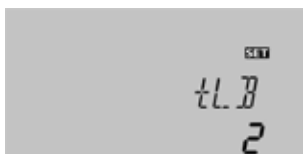
*LLOGI / TRUN*

Oscillating loading time

Adjustment range: 1 ... 30 min

Factory setting: 15 min

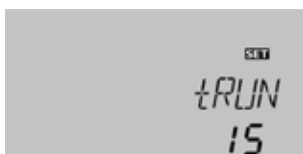
**Note:**

If priority **Su 1** or **Su 2** is adjusted, solar loading of the subordinate tank will be interrupted, if the temperature of the priority tank (tank1 for Su 1, tank 2 for Su 2) falls below its adjusted maximum temperature. If, in that case, the temperature difference between the priority tank and the collector is not sufficiently high, solar loading will be stopped completely.

The antifreeze function activates the loading circuit between the collector and the tank when the temperature falls below the adjusted temperature **CFR O**. This will protect the fluid against freezing or coagulating. If **CFR F** is exceeded, the solar pump will be switched off again.

The antifreeze function will be suppressed if the tank temperature of the selected tank falls below 42 °F. In 2-tank systems, the function will switch to the second tank, in systems with vertical tank loading, it will switch to the upper tank zone. If the temperature of the second tank (or of the upper tank zone respectively) also falls below 42 °F, the system will be switched off.

**Note:**

Since this function uses the limited heat quantity of the tank, the antifreeze function should be used in regions with few days of temperatures around the freezing point.

**Note:**

This function can only become active if the tank temperature is higher than the collector temperature.

Priority logic can be used in 2-tank systems or systems with vertical tank loading only and determines how the heat is divided between the tanks. Different types of priority logic are adjustable:

tank sequence control (1 and 2)

successive loading (Su 1 and Su 2)

parallel loading (0)

1. If **PRIO 1** or **PRIO 2** is adjusted, the corresponding tank (1=tank 1; 2=tank 2) will be loaded with priority if its switch-on conditions are fulfilled and if it is not blocked. If the priority tank is not blocked but its switch-on conditions are not fulfilled, the tank sequence control starts provided that the switch-on conditions of the subordinate tank are fulfilled.

If a subordinate tank can be loaded, it will be loaded for the oscillating loading time **tRUN**. After the loading time has ended, the pump is switched off for the loading break **tLB**. If during this time the priority tank can be loaded, it will be loaded. If the priority tank has reached its maximum temperature, the subordinate tank will be loaded up to its maximum temperature without oscillating loading logic.

2. If priority **Su 1** or **Su 2** is adjusted, the priority tank will be loaded up to its maximum temperature. If the maximum temperature is reached, the second tank will be loaded. If the temperature of the first tank falls below **SMAX**, the second tank will no longer be loaded, regardless of whether the switch-on conditions of the priority tank or of the subordinate tank are fulfilled or not.

3. In systems with 2 pumps, both tanks will be loaded if the corresponding switch-on conditions are fulfilled if **PRIO 0** is adjusted.

In systems with 3-port valves, the tank with the lowest temperature will be loaded first until its temperature is by 10 °R above the other tank. Loading will be switched to the other tank. Then, the 2 tanks will be loaded alternately in steps of 10 °R.

Tank set option*LLOGI / PRIO / OST5*

Tank set option
 Selection ON / OFF
 Factory setting: OFF

*LLOGI / PRIO / TST1*

Set temperature tank 1
 Adjustment range: 38 ... 185 °F
 Factory setting: 110 °F

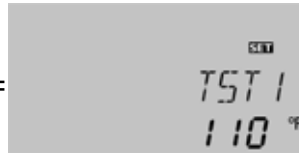
*LLOGI / PRIO / TST2*

Set temperature tank 2
 Adjustment range: 38 ... 185 °F
 Factory setting: 110 °F

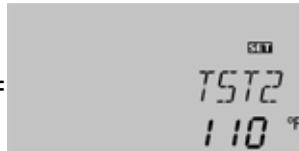
**Spreaded loading option**

(for PRIO 1, 2, Su 1 or Su 2 only)

LLOGI / PRIO / OSE

Spreaded loading option
 Selection: ON / OFF
 Factory setting: OFF

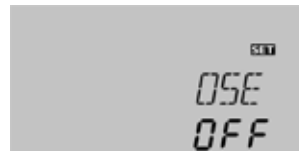
*LLOGI / PRIO / DTSE*

Temperature diff. Spreaded
 loading
 Adjustment range: 40 ... 160 °R
 Factory setting: 70 °R

**Pause control***LLOGI / PSPEE*

Pause speed
 Selection: ON / OFF
 Factory setting: OFF

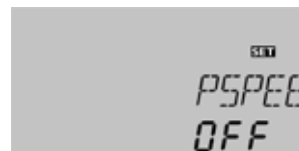
*LLOGI / PDELA*

Pump delay
 Selection: ON / OFF
 Factory setting: OFF

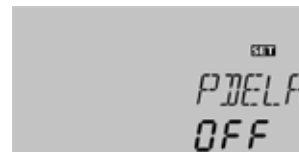

Additionally, the following options can be activated:

Tank set option OST5: If the selected priority tank reaches its set temperature, the subordinate tank will be loaded until it reaches its set temperature. After that, the priority tank will be loaded up to its maximum tank temperature, then the subordinate tank. This function is available in all 2-tank systems.

Spreaded loading option OSE: In 2-tank systems with 2 pumps, a spreaded loading function can be activated.

As soon as the adjustable spread difference **DTSE** between the collector and the priority tank is reached, the second tank will be loaded in parallel unless it is blocked. If the temperature difference falls by 4 °R below **DTSE**, the pump is switched off.

The collector temperature has to be higher than the tank temperature.

This function takes into account the actuation times of valves and switches on the pump with a delay.

If the pause speed is activated, the relay of the tank which has been loaded last remains switched on during the loading break time. Speed is determined by the value adjusted in nLO.

If the pump delay is activated, the corresponding relay for the valve will be energized first. The pump(s) will be activated with the delay time (200s).

**Note:**

In systems with pump logic, the parameter **PDELA** is not available.

Drainback option

LLOGI / ODB

Drainback option

Selection: ON / OFF

Factory setting: OFF

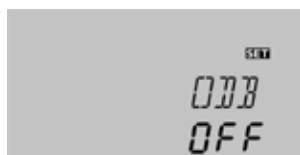

A drainback system permits the heat transfer fluid to drain back into the holding tank when solar energy is not collected. The drainback option will initiate the filling of the system when solar loading begins. If the function is activated, the menu items described in the following (**tD_{TO}**, **tF_{LL}** and **tS_{TB}**) have to be adjusted:

**Note:**

A drainback system requires additional components such as a holding tank. The drainback option should only be activated if all components required are properly installed.

**Note:**

The drainback option is only available in system with one tank and one collector field and if no cooling function is activated.

**Note:**

If the drainback option **ODB** is activated, the cooling functions and the antifreeze function will not be available.

**Note:**

If the drainback option **ODB** is activated, the factory settings of the parameters **DT_O**, **DT_F** and **DT_S** will be adapted to values suiting drainback systems. Additionally, the adjustment range and the factory setting of the collector emergency shutdown **CEM** will change.

Previous adjustments made in these channels will be overridden and have to be entered again if **ODB** is deactivated later on.

Time period - switch-on condition

LLOGI/ODB/TOTO

Time period - switch-on condition

Adjustment range: 1 ... 100 s
in steps of 1 s

Factory setting: 60 s

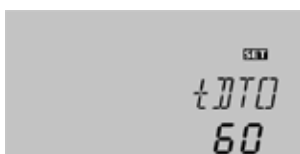

The parameter **tD_{TO}** is used for adjusting the time period during which the switch-on condition **DT_O** must be permanently fulfilled.

Filling time

LLOGI/ODB/TFLL

Filling time

Adjustment range:

1.0 ... 30.0 min

in steps of 0.5 min

Factory setting: 5.0 min

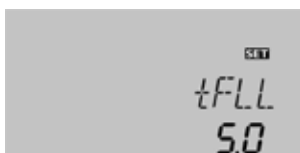

The filling time can be adjusted using the parameter **tF_{LL}**. During this period, the pump runs at 100 % speed.

Stabilization

LLOGI/ODB/TSTB

Stabilization

Adjustment range:

1.0 ... 15.0 min

in steps of 0.5 min

Factory setting: 2 min

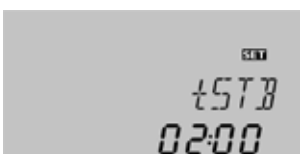

The parameter **tS_{TB}** is used for adjusting the time period during which the switch-off condition **DT_F** will be ignored after the filling time has ended.

Booster function

LLOGI/ODB/OBST

Booster function

Adjustment range: ON / OFF

Factory setting: OFF

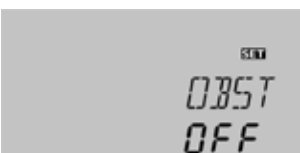

This function is used for switching on a second pump when filling the solar system. When solar loading starts, R3/R4 is energized in parallel to R1. After the filling time (**tF_{LL}**) has ended, R2 is switched off.

**Note:**

The booster function is available in systems 1, 3, 8, 9, and 10 only.

Overrun

LLOGI/OOVRU

Selection: ON / OFF

Factory setting: OFF

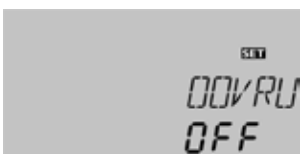

By means of this function, tank loading continues after the temperature difference between the collector and the tank has fallen below the switch-off difference. Tank loading is stopped if the adjusted ΔT overrun difference between flow and return sensor is underrun.

LLOGI/DTOVR

Adjustment range: 0.0 ... 40.0 °R
Factory setting: 10 °R

**Cooling functions****System cooling****COOL / OSYC**

System cooling option
Adjustment range: ON / OFF
Factory setting: OFF

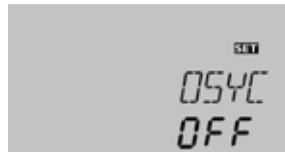
**COOL / DTCD**

Switch-on temperature diff.
Adjustment range: 2.0 ... 60.0 °R
Factory setting: 40.0 °R

**COOL / DTFC**

Switch-off temperature diff.
Adjustment range: 1.0 ... 59.0 °R
Factory setting: 30.0 °R

**Tank cooling****COOL / OSTC**

Option tank cooling
Adjustment range: ON / OFF
Factory setting: OFF

**Heat dump****COOL / OHDP**

Heat dump function
Selection: ON / OFF
Factory setting: OFF

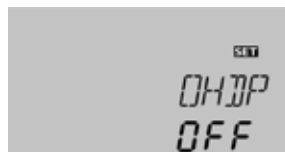
**COOL / OTCL**

Overtemperature collector
Adjustment range: 150 ... 320 °F
Factory setting: 230 °F

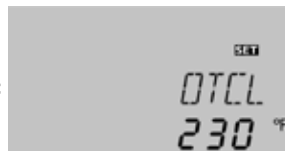
**COOL / OTPUM**

Pump or valve logic
Selection: ON / OFF
Factory setting: OFF

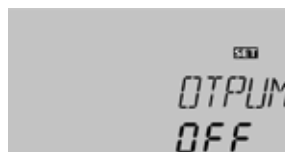
**COOL / HDREL**

Relay heat dump function
Selection: system dependent
Factory setting: 3

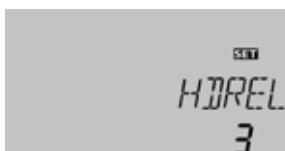
**Note:**

The overrun function is only available, if both Grundfos sensors (VFS and RPS) are used.

Different cooling functions can be activated: system cooling, tank cooling and heat dump.

**Note:**

If the temperature at the tank sensor reaches 200 °F, all cooling functions will be blocked. The switch-on hysteresis is 10 °R.

The system cooling function aims to keep the solar system operational for a longer time. The function overrides the maximum tank temperature to provide thermal relief of the collector field and the heat transfer fluid on hot days.

If the tank temperature is higher than the adjusted maximum tank temperature and the switch-on temperature difference **DTCD** is reached, the solar system remains activated or is switched on. Solar loading is continued until either the temperature difference falls below the adjusted value **DTFC** or the collector emergency shutdown temperature **CEM** is reached.

If the system cooling function is active, ☀ is shown on the display (flashing).

**Note:**

This function will only be available if the collector cooling function, the heat dump function, and the drainback option are deactivated.

When the tank cooling function is activated, the controller aims to cool down the tank during the night in order to prepare it for solar loading on the following day.

If the adjusted maximum tank temperature (**S MAX / S1MAX / S2MAX**) is exceeded and the collector temperature falls below the tank temperature, the system will be reactivated in order to cool down the tank.

Reference temperature differences are **DT O** and **DT F**.

If the heat dump function **OHDP** is activated, the selected relay is energized with 100%, if the collector temperature reaches the adjusted collector overtemperature **OTCL**.

If the collector temperature falls by 10 °R below the adjusted collector overtemperature **OTCL**, the relay will be switched off.

A selection can be made between pump logic and valve logic (**OTPUM ON** = pump logic, **OTPUM OFF** = valve logic).

If pump logic is selected, the relay for solar loading switches off and the relay for heat dump remains switched on.

The relay for the heat dump function can be selected in the **HDREL** channel.

**Note:**

The adjustable value **OTCL** is locked against the collector emergency temperature **CEM** by 20 °R. The heat dump will only be available if the collector cooling function, the system cooling function, and the drainback option are deactivated.

Heat exchange function / solid fuel boiler / return preheating

DT3 / DT30

Switch-on temperature diff.
Adjustment range: 2.0 ... 90.0 °R
in steps of 1.0 °R
Factory setting: 12.0 °R

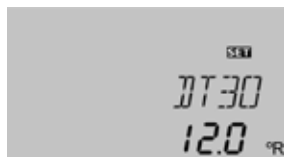

DT3 / DT3F

Switch-off temperature diff.
Adjustment range: 1.0 ... 89.0 °R
in steps of 1.0 °R
Factory setting: 8.0 °R

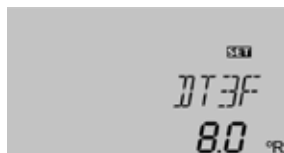

DT3 / DT3S

Set temperature diff.
Adjustment range: 3.0 ... 90.0 °R
in steps of 1.0 °R
Factory setting: 20.0 °R

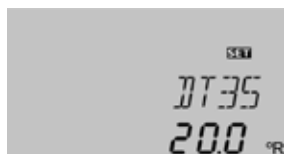

DT3 / RIS3

Rise
Adjustment range: 2 ... 40 °R
in steps of 2 °R
Factory setting: 4 °R

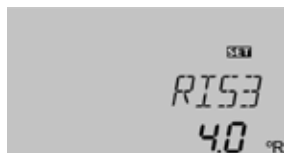

The heat exchange function is used for transporting heat from tank 1 to tank 2.

Additionally, minimum and maximum temperature limits and the corresponding switch-on and switch-off differences can be set for the independent temperature differential control. Both switch-on and switch-off temperature differences **DT30** and **DT3F** as well as the set temperature difference **DT3S** and rise **RIS3** are valid.

Maximum temperature limitation

DT3 / MAX30

Switch-on temperature
Adjustment range: 3
0.0...200.0 °F
Factory setting: 140 °F



DT3 / MAX3F

Switch-off temperature
Adjustment range:
30.0...200.0 °F
Factory setting: 136 °F



If the adjusted value **MAX30** is exceeded, the relay will be switched off. If the temperature falls below the adjusted value **MAX3F**, the relay will be energized.

Reference sensor:

S3 for ARR 8, 13, 26 (TSTT)

S4 for ARR 2, 11, 16, 17, 18, 24 (TST2B)

Minimum temperature limitation

DT3 / MIN30

Switch-on temperature
Adjustment range:
30.0 ... 190.0 °F
Factory setting: 40 °F

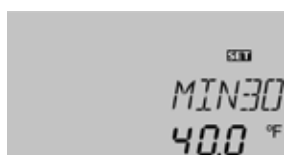

DT3 / MIN3F

Switch-off temperature
Adjustment range:
30.0 ... 190.0 °F
Factory setting: 50 °F



If the temperature falls below the adjusted value **MIN30**, the relay will be switched off. If the adjusted value **MIN3F** is exceeded, the relay will be energized.

Reference sensor:

S3 for ARR 8, 13, 26 (TSFB)

S4 for ARR 2, 11, 16, 17, 18, 24 (TSTT)

ARR= 2, 11, 16, 17, 18
MIN30 40 °F
MIN3F 50 °F
ARR= 8, 13, 26
MIN30 140 °F
MIN3F 149 °F

DT3 / S2DT3

Reference sensor tank 1
Selection: 2, 3
Factory setting: 3
Reference sensor tank 2
Selection: 4, 5
Factory setting: 4

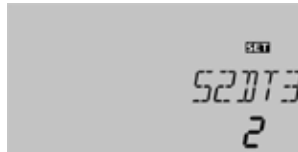

The reference sensor for the heat exchange function (heat source) for tank 1 is sensor S3 (TSTT). The reference sensor (heat sink) for tank 2 (S2DT3) is S4. It can be changed to S5 and is used for the differential function and the maximum limitation.

For the solid fuel boiler function, the reference sensor (heat source) for the solid fuel boiler is sensor S4. The reference sensor (heat sink) for the tank is S3, but it can be changed to S2.

Allocation of a sensor for the minimum and maximum limitation, instead of S4/S3.

Return preheating*DT3 / S2DT3*

Reference sensor
Selection: 3, 5
Factory setting: 3

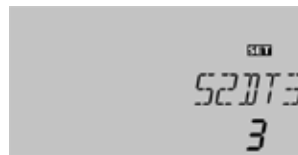

In order to heat the heating circuit return by means of heat supplied by the solar circuit, the controller is equipped with a return preheating function.

If the switch-on temperature difference **DT30** between the sensors S3 or S5 (TSTR) and S4 (TRET) is exceeded, a 3-port valve for heating circuit backup is controlled via the relay output R2/R3. Free sensors (S3 or S5) can be allocated for this function (S2DT3).

**Note:**

In systems with east-/west collectors, S5 is not available.

Thermostat function

Backup heating

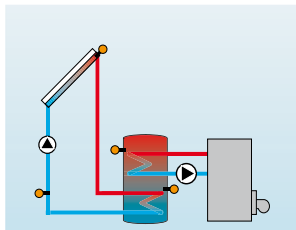

Use of surplus energy

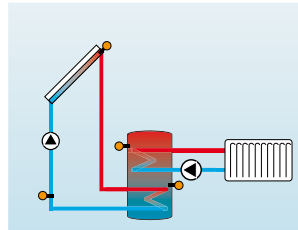

The thermostat function works independently from the solar operation and can be used for using surplus energy or for backup heating.

- **AH O < AH F**
thermostat function for backup heating
- **AH O > AH F**
thermostat function for using surplus energy

AH / AH O

Thermostat switch-on temp.
Adjustment range: 30...480 °F
in steps of 1 °F
Factory setting: 110 °F

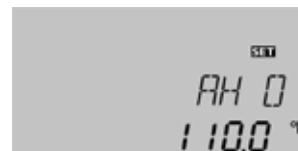
*AH / AH F*

Thermostat switch-off temp.
Adjustment range: 30...480 °F
in steps of 1 °F
Factory setting: 120 °F

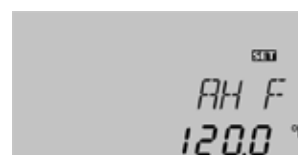

AH / T10

Switch-on time 1

Adjustment range: 00:00...23:45

Factory setting: 06:00

in steps of 15 min

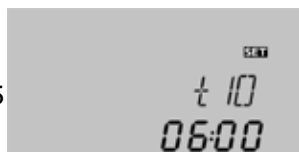
*AH / T1F*

Switch-off time 1

Adjustment range: 00:00...23:45

Factory setting: 22:00

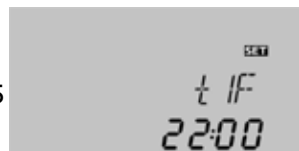
*AH / T2 (3) 0*

Switch-on time 2 (3)

Adjustment range: 00:00 ... 23:45

Factory setting: 00:00

AH / T2 (3) F

Switch-off time 2 (3)

Adjustment range: 00:00 ... 23:45

Factory setting: 00:00

In order to block the thermostat function for a certain period, there are three time frames t1 ... t3. The switch-on and switch-off times can be adjusted in steps of 15 minutes. If the switch-on and the switch-off time are identical, the time frame is inactive.

If the thermostat function should run from 06:00 a.m. and 09:00 a.m. only, adjust t1O to 06:00 a.m. and t1F to 09:00 a.m.

The first time frame is factory set from 06:00 to 22:00.

If all time frames are set to 00:00, the thermostat function is solely temperature dependent.

Manual mode*MAN / MAN1 (2, 3):*

Adjustment range:

Auto, ON, OFF, nLO, nHI

Factory setting: Auto

*MAN / MAN4*

Adjustment range:

Auto, ON, OFF

Factory setting: Auto



For control and service work, the operating mode of the controller can be manually adjusted. For this purpose, select the adjustment value **MAN**. The following adjustments can be carried out:

Auto : relay in automatic mode

ON : relay is switched on

OFF : relay is switched off

nLO : relay is switched with adjusted minimum speed

nHI : relay is switched with adjusted maximum speed

**Note:**

Always adjust the operating mode back to "Auto" when the control and service work is completed. Otherwise normal operation will not be possible.

Blocking protection option**Blocking protection***BLPR1(2, 3)*

Blocking protection

Selection: ON / OFF

Factory setting: OFF

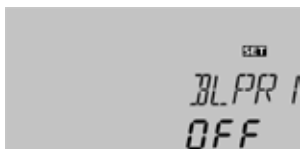

In order to protect the pumps against blocking after standstill, the controller is equipped with a blocking protection function. This function switches on the relays 1-3 every day at 12:00 a.m. for 10 s at 100%.

Option: Thermal disinfection (OTDIS)*OTDIS*

Thermal disinfection function
Adjustment range: ON / OFF
Factory setting: OFF

*OTDES / PDIS*

Monitoring period
Adjustment range:
0 ... 30:0 ... 24 (dd:hh)
Factory setting: 01:00

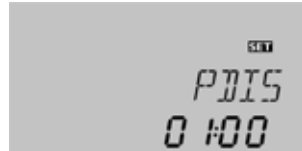
*OTDES / DDIS*

Heating period
Adjustment range:
00:00...23:59
Factory setting: 01:00

*OTDES / TDIS*

Disinfection temperature
Adjustment range: 30...200 °F
in steps of 2 °F
Factory setting: 140 °F

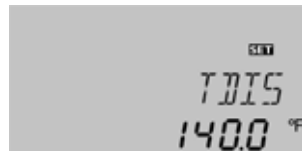
**Note:**

If the thermal disinfection option **OTDIS** is activated, the display channels **TDIS** and **CDIS** will be displayed. **TDIS** will be displayed regardless of the temperature measured at the reference sensor.

Thermal disinfection with starting delay*OTDIS / SDIS*

Starting time
Adjustment range:
00:00 ... 24:00
Factory setting: 18:00
(6:00 p.m.) full hours only

**Reference sensor for the thermal disinfection is S3! It is possible to adjust this sensor in the channel TSDIS.**

This function is used for protecting the upper tank zone against legionella by activating the backup heating. For thermal disinfection, the temperature in the upper DHW tank zone has to be monitored. This protection is ensured when, during the monitoring period **PDIS**, the disinfection temperature **TDIS** is continuously exceeded for the entire heating period **DDIS**. S3 is used as the reference sensor and displayed as **TSTT**.

If **OTD** is activated, **PDIS** will start as soon as the temperature at S3 falls below **TDIS**. The display channel **CDIS** appears, counting backwards the remaining time of **PDIS**. If, during the monitoring period, the temperature at S3 exceeds **TDIS** continuously for the duration of **DDIS**, thermal disinfection is considered complete and a new monitoring period begins.

If **CDIS** counts down to 00:00, relay 2 will be operated in order to use the backup heating for thermal disinfection. **CDIS** will then be replaced with a display channel **DDIS** showing the adjusted heating period. **DDIS** will start counting down the heating period as soon as **TDIS** is exceeded at S3. As long as **DDIS** is active, the temperature at S3 will be displayed as **TDIS** instead of **TSTT**.

If, during **DDIS**, the temperature at S3 exceeds **TDIS** by more than 10 °R, relay 2 is switched off until the temperature falls below **TDIS** + 4 °R.

If, during **DDIS**, the temperature at S3 falls below **TDIS**, the heating period will restart. **DDIS** can only be completed when **TDIS** is exceeded without interruption.

Due to the flexible control logic, the exact time of thermal disinfection is not predictable. In order to set a fixed time for the disinfection to be run, the starting delay **SDIS** must be used:

When a starting time for thermal disinfection with starting delay is adjusted in **SDIS**, the thermal disinfection will be delayed until that time, even after the **CDIS** has counted down to 00:00. If **CDIS** ends, for example, at 12:00, and **SDIS** has been set to 18:00 (6:00 p.m.), relay 2 will be operated with a delay of 6 hours at 18:00 (6:00 p.m.) instead of 12:00.

During the waiting time, **SDIS** is displayed with the adjusted starting time (flashing).

If, during the waiting time, the temperature at S3 exceeds **TDIS** for the adjusted heating period **DDIS**, thermal disinfection is considered complete and a new monitoring period begins.

If the starting time is adjusted to 00:00 (factory setting), the delay function is inactive.

Upon delivery, **OTDIS** is deactivated. The adjustment values **PDIS**, **TDIS**, **DDIS** and **SDIS** are displayed after the option has been activated. After the thermal disinfection function has been completed, the values will be "hidden" and the monitoring period will be displayed.

OTDIS / TSDIS

Sensor thermal disinfection
Adjustment range 2, 3, 4, 5
Factory setting: 3

**OTDIS / RDIS**

Relay thermal disinfection
Adjustment range 2, 3, 4
Factory setting: 3

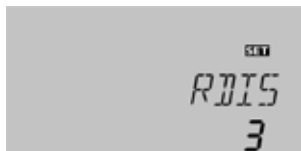
**Parallel relay****OPARR / PARRE**

Parallel relay
Adjustment range 2, 3, 4
Factory setting:
system-dependent

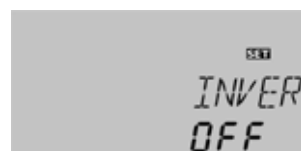

For this function, free sensors at an appropriate position can be selected. Reference sensor for the thermal disinfection is S3.

The relay for the thermal disinfection function can be selected.

With this function, e. g. a valve can be controlled in parallel to the pump via a separate relay **PARRE**.

If solar loading takes place (R1 and/or R2) or if a solar function is active, the relay selected will be energized. The parallel relay can also be energized inversely (**INVER**).

**Note:**

If R1 and/or R2 are in the manual mode, the selected parallel relay will not be energized.

Energy metering**OHQM**

Energy metering
Adjustment range: ON / OFF
Factory setting: OFF

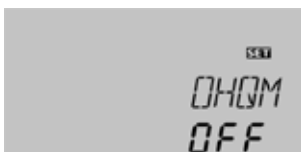
**OHQM / FTYPE**

Flow rate detection type
Selection: 1, 2, 3
Factory setting: 1



Energy metering can be carried out in 3 different ways (see below): without flowmeter V40, with flowmeter V40 or with Grundfos sensor.

→ Enable the energy metering option in the channel **OHQM**.

→ Select the type of flow rate detection in the channel **FTYPE**.

Flow rate detection type:

- 1 : fixed flow rate value
- 2 : V40
- 3 : VFS sensor

**Note:**

Type 3 can only be selected if the Grundfos sensors have been activated in the channel GFDS.

OHQM / FMAX

Flow rate
Adjustment range:
0.5... 100.0 l/min
in steps of 0.1 l/min
Factory setting: 6.0 l/min

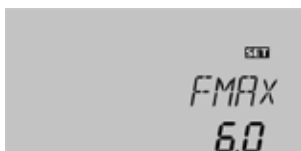
**OHQM / MEDT**

Heat transfer fluid
Adjustment range: 0...3
Factory setting: 3

**Energy metering with fixed flow rate value**

The energy metering calculation (estimation) uses the difference between flow and return temperature and the entered flow rate (at 100 % pump speed).

→ Adjust **1** in the channel **FTYPE**

→ Read the flow rate (l/min) and adjust it in the channel **FMAX**.

→ Adjust the antifreeze type and concentration of the heat transfer fluid in the channels **MEDT** and **MED%**.

**Note:**

FMAX cannot be selected in systems with 2 solar pumps (ARR 6, 7, 17, 18, 19, 20, 21, 22, 23, 24, 25, 26).

OHQM / MED%

Antifreeze concentration in vol.%
 MED% is "hidden" when MEDT 0 or 3 is used
 Adjustment range: 20 ... 70%
 in steps of 1 %
 Factory setting: 45 %

**Antifreeze type:**

- 0 : water
- 1 : propylene glycol
- 2 : ethylene glycol
- 3 : Tyfocor® LS / G-LS

OHQM / FIMP

Impulse rate
 Adjustment range: 0.5 ... 99.0
 in steps of 0.1
 Factory setting: 1.0

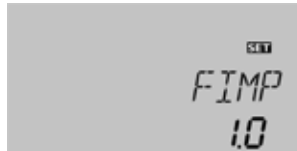
**Energy metering with flowmeter V40**

- **2FTYPEFIMP** MED% Energy metering with VFS sensor:
- **FTYPEMEDT** MED%

HQM sensors*OHQM / SFHQM*

Flow sensor
 Adjustment range: 1, 2, 3, 5
 Factory setting: 1

*OHQM / SRHQM*

Return sensor
 Adjustment range: 2, 3, 4, 5
 Factory setting: 4



If the flow rate detection type FMAX or V40 has been adjusted, the flow and the return sensor for energy metering can be selected.

- In the channel **SFHQM** select the flow sensor.
- In the channel **SRHQM** select the return sensor.

For this function, free sensors at an appropriate position can be selected. The pre-adjusted flow sensor is S1, the return sensor is S4.

Grundfos sensors and flow rate monitoring*GFDS / VFS*

Selection: OFF / 1-12 / 2-40
 Factory setting: OFF

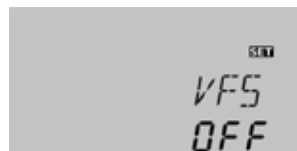
*GFDS / RPS*

Selection: OFF / 0-10
 Factory setting: OFF

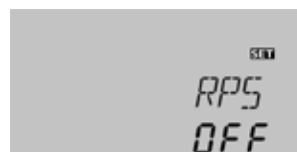
*GFDS / OFLOW*

Selection: ON / OFF
 Factory setting: OFF

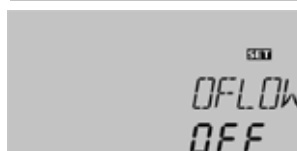

In this menu point the Grundfos sensors can be registered. If Grundfos sensors (VFS) are connected and registered, flow rate monitoring **OFLOW** can be carried out during solar loading. If no flow rate has been detected for 30 s, the error message **EFLOW** is displayed in the status menu (see flow rate monitoring option).

**Note:**

To deactivate the VFS or the RPS sensor, the functions using these sensors have to be deactivated first.

Overpressure*PRS > OVPR*

Overpressure

Adjustment range: ON / OFF

Factory setting: OFF

*PRS / OVPRO*

on at

Adjustment range: 0.6 ... 6.0 bar

Factory setting: 5.5 bar

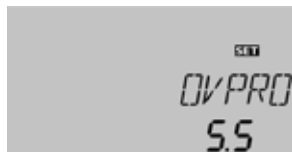
*PRS / OVPRF*

off at

Adjustment range: 0.3 ... 5.7 bar

Factory setting: 5.0 bar

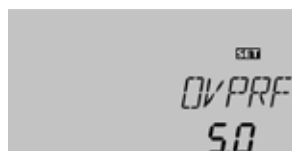
**Low pressure (leakage)***PRS / OLEAK*

Low pressure

Adjustment range: ON / OFF

Factory setting: OFF

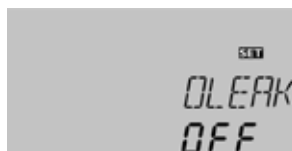
*PRS / LEAKO*

on at

Adjustment range: 0.3 ... 5.7 bar

Factory setting: 0.7 bar

*PRS / LEAKF*

off at

Adjustment range: 0.6 ... 6.0 bar

Factory setting: 1.0 bar

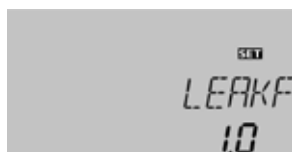
**Time and date.***DATE/TIME*

Time

Adjustment range:

00:00...23:59

Factory setting: 12:00

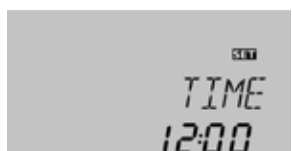
*DATE/4444*

Year

Adjustment range:

2010...2099

Factory setting: 2010

*DATE/MM*

Month

Adjustment range: 01...12

Factory setting: 03

*DATE/DD*

Day

Adjustment range: 01...31

Factory setting: 15

**Temperature unit***UNIT*

Temperature unit

Selection: °C, °F

Factory setting: °F



If the system pressure exceeds the adjustable maximum value **OVPRO**, an error message will appear. If the system pressure exceeds or falls below the switch-off threshold, the relay will be deblocked.

In the case of an overpressure, the message **EPRES** will be displayed.

**Note:**

The monitoring function is only available, if the Grundfos sensor RPS is used.

The switch-on threshold (factory setting 0.7 bar) can be adjusted. If the system pressure falls below the adjusted value, the error message is displayed until the system pressure exceeds the switch-off threshold (factory setting 1.0 bar).

In the case of low pressure, the message **ELEAK** will be displayed.

**Note:**

The monitoring function is only available, if the Grundfos sensor RPS is used.

The date and time can be entered. Both are required for the thermostat function.

In the display, the upper line indicates the day followed by the month. The lower line indicates the year.

In this adjustment channel the temperature unit can be chosen.

The unit can be switched between °C and °F during operation.

Language*LANG*

Language

Selection: dE,En

Factory setting: En

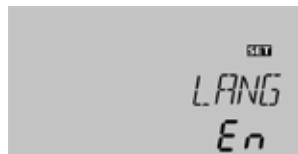

In this adjustment channel, the menu language can be chosen.

- dE : German
- En : English

SD card*OSDC / OSDC*

SD card

Selection: ON / OFF

Factory setting: OFF

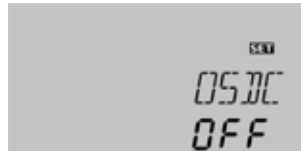

If an SD card is used, **COM** is shown on the display. If the SD card is full, **COM** is flashing.

Starting the logging

→ Insert the SD card into the slot

Logging will start immediately.

→ Adjust the desired logging interval

OSDC / LOGI

Logging interval

Adjustment range: 1 ... 1200 s

Factory setting: 60 s



When **LLOG** is activated, data logging will stop if the capacity limit is reached. The message **CFULL** will be displayed.

When **LLOG** (linear logging) is deactivated, the oldest data logged onto the SD card will be overwritten as soon as the capacity limit is reached.

OSDC / LLOG

Linear logging

Selection: ON / OFF

Factory setting: OFF

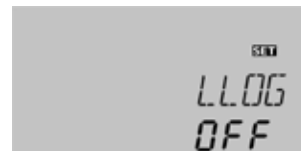
**Completing the logging process**

→ Select the menu item **REMC**

→ After **-REM** is displayed remove the card from the slot

OSDC / REMC

Safely remove card

Selection: ON / OFF

Factory setting: OFF

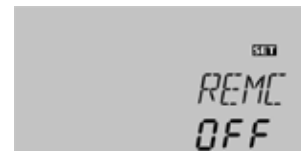
**Formatting the SD card**

→ Select the menu item **FORM**

During the formatting process, **--FORM** will be displayed.

The content of the card will be deleted and the card will be formatted with the FAT file system.

OSDC / FORM

Format card



Messages possible	Description
FSYS	File system error
CTYP	Card type is not supported
WRIT	Error during writing
NOCRD	No card in slot
LOGG	Logging is possible
WRITP	Card is write-protected
CFULL	Card full
RTIME	Remaining logging time in days

Messages possible	Description
REMC	Safely remove card command
-REM	Card is being removed
FORM	Formatting SD card command
--FORM	Formatting in progress
LOGI	Logging interval in min
LLOG	Linear logging

**Note:**

Because of the increasing size of the data packets, the remaining logging time does not decrease linearly. The data packet size can increase, e. g. with the increasing operating hours value.

6.3 Overview of options and their parameters

In the following, the additional options and parameters are listed.

The options and parameters displayed depend on the system as well as on the options and functions which have

been selected. Some of the options and parameters will only be displayed, if they are available with the individual adjustments.

Channels						
Channel	Sub channel 1	Sub channel 2	Factory setting	Change to	Description	Page
ARR					Arrangement	78
LLOGI >					Loading logic	84
	ODB >				Drainback option	84
		tDTO	60 s		Time period - switch-on condition	84
		tFLL	5 min		Filling time	84
		tSTB	2 min		Stabilization	84
		OBST	OFF		Booster function	84
	OOVRU*		OFF		Overrun option	84
	DTOVR		10 °R		Overrun	84
COOL >					Cooling functions	85
	OSYC**		OFF		System cooling	85
	DTCO		40 °R		Switch-on difference system cooling	85
	DTCF		30 °R		Switch-off difference system cooling	85
	OSTC		OFF		Tank cooling	85
	OHDP**		OFF		Heat dump	85
	OTCL		230 °F		Overtemperature collector	85
	OTPUM		OFF		Pump or valve logic	85
PUMP >					Pump speed	79
	PUMP1		OnOF		Speed variant pump 1	79
	n1LO		30 %		Minimum speed	79
	n1HI		100 %		Maximum speed	79
	PUMP2		OnOF		Speed variant pump 2	79
	n2LO		30 %		Minimum speed	79
	n2HI		100		Maximum speed	79
	PUMP3		OnOF		Speed variant pump 3	79
	n3LO		30 %		Minimum speed	79
	n3HI		100%		Maximum speed	79
OTDIS >					Thermal disinfection option	89
	PDIS		01:00		Monitoring period (interval)	89
	DDIS		01:00		Heating period (duration of disinfection)	89
	TDIS		140 °F		Disinfection temperature	89
	SDIS		00:00		Starting time	90
	TSDIS		3		Temperature sensor for disinfection	90
	OTDIS		ON		Deactivation Thermal disinfection	90
OPARR >					Parallel relay option	90
	PARRE		2		Parallel relay	90
	INVER		OFF		Inversion	90
OHQM >					Energy metering option	90
	FTYPE		1		Flow rate detection type	90
	FMAX		6 l/min		Adjustable maximum flow rate	90
	FIMP		1 l/Imp		Pulse rate	91
	MEDT		1		Antifreeze type	90
	MED%		40		Antifreeze concentration	91
	SFHQM		1		Sensor flow HQM	91
	SRHQM		4		Sensor return HQM	91
GFDS >					Registration Grundfos sensors	91
	VFS		OFF		Range of flow rate sensor	91
	RPS		OFF		Range of pressure sensor	91
	OFLOW		OFF		Flow rate monitoring option	91
PRS* >					Pressure monitoring option	92
	OOVPR		OFF		Overpressure	92
	OVPRO		5.5 bar		Overpressure - switch-on value	92

Channels						
Channel	Sub channel 1	Sub channel 2	Factory setting	Change to	Description	Page
	OVPRF		5.0 bar		Overpressure - switch-off value	92
	OLEAK		OFF		Low pressure	92
	LEAKO		0.7 bar		Low pressure - switch-on value	92
	LEAKF		1.0 bar		Low pressure - switch-off value	92
DATE>					Enter date	92
	TIME		12:00		Time	92
	YYYY		2010		Year	92
	MM		03		Month	92
	DD		15		Day	92
LANG >			En		Language	93
UNIT >			°F		Unit	92
OSDC >					SD card option	93
CODE			0000		User code	
RESET			OFF		Factory setting	

* This channel is only available if the Grundfos sensors have been registered in the **GFDS** channel.

** are blocked against each other

7 User code and short menu - Adjustment values

CODE

The access to some adjustment values can be restricted via a user code (customer). For safety reasons, the user code should generally be set to the customer code before the controller is handed to the customer!

1. Expert **0262** (Factory setting)

All menus and adjustment values are shown and all values can be altered.

2. Customer **0000**

The expert level is not shown, adjustment values can be changed partly (see below)

→ In order to restrict the access, enter 0000 in the menu item **CODE**.

The display changes to the status level. If the adjustment channel is selected afterwards, the short menu shown below will be available. The short menu suits the selected system.

→ In order to authorize the access, enter 0262 in the menu item **CODE**.

Channel	Factory setting	Adjustment range	Description
TIME	12:00	00:00 ... 23:59	Time
DT O	12 °R	2.0 ... 90.0 °R	Switch-on temperature difference tank
DT F	8 °R	1.0 ... 89.0 °R	Switch-off temperature difference tank
DT S	20 °R	3.0 ... 90.0 °R	Set temperature difference tank
S MAX	140 °F	40 ... 200 °F	Tank maximum limitation
DT1O	12 °R	2.0 ... 90.0 °R	Switch-on temperature difference tank 1
DT1F	8 °R	1.0 ... 89.0 °R	Switch-off temperature difference tank 1
DT 1S	20 °R	3.0 ... 90.0 °R	Set temperature difference tank 1
S1MAX	140 °F	40 ... 200 °F	Tank maximum limitation tank 1
DT2O	12 °R	2.0 ... 90.0 °R	Switch-on temperature difference tank 2
DT2F	8 °R	1.0 ... 89.0 °R	Switch-off temperature difference tank 2
DT 2S	20 °R	3.0 ... 90.0 °R	Set temperature difference tank 2
S2MAX	140 °F	40 ... 200 °F	Tank maximum limitation tank 2
LST2	ON	ON / OFF	Loading tank 2 on
MAN1	Auto	Auto / ON / OFF / n LO / n HI	Manual operation pump 1
MAN2	Auto	Auto / ON / OFF / n LO / n HI	Manual operation pump 2
MAN3	Auto	Auto / ON / OFF / n LO / n HI	Manual operation pump 3
MAN4	Auto	Auto / ON / OFF	Manual operation pump 4
CODE	0000	0000 / 0262	User code

8 Messages

In the case of an error, the directional pad flashes red and a message is indicated in the status display. A warning triangle is additionally indicated. If more than one error or fault condition has occurred, only the one with the highest priority will be displayed as a message in the status display.

In the case of a sensor error, the system is switched off, and a message appears on the display marked by an "E". Additionally, a corresponding value for the error type assumed is indicated.



After the error has been removed, the error message disappears.

Error message	Value	Description	Solution
FS1...7	-88.8	Short circuit at sensor 1...7	Check the cable
FS6, 8	888.8	Broken cable at sensor 6, 8	
EVFS	9999	Error at VFS sensor	Sensor fault. Check and, if necessary, correct the connection of the sensor plugs. If a sensor signal does not appear, the sensor has to be replaced
ERPS	9999	Error at RPS sensor	
ELEAK	Measured minimum pressure	Leakage error	Check the system for a leakage
EPRES	Measured maximum pressure	Error pressure	Check the functioning of the valves and pumps
EFLOW		Error flow rate Threshold values for VFS 1-10: 1,0-1,1 l/min Threshold values for VFS 2-40: 2,0-2,1 l/min	Check the pump Check whether a flow rate exists
PARAM		Remote parametrization	Do not parametrize the controller via the push buttons during remote parametrization

9 Troubleshooting

If a malfunction occurs, a message will appear on the display of the controller.



Directional pad flashes red. The symbol  is indicated on the display and the symbol  flashes.

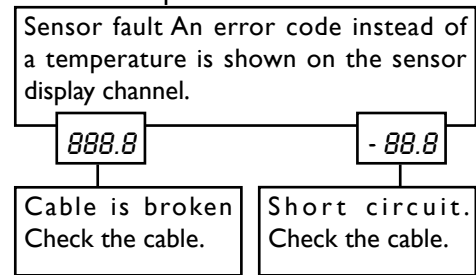

Disconnected PT1000 temperature sensors can be checked with an ohmmeter. Please check the resistance values correspond with the table.

°F	Ω	°F	Ω
14	961	131	1213
23	980	140	1232
32	1000	149	1252
41	1019	158	1271
50	1039	167	1290
59	1058	176	1309
68	1078	185	1328
77	1097	194	1347
86	1117	203	1366
95	1136	212	1385
104	1155	221	1404
113	1175	230	1423
122	1194	239	1442

resistance of the Pt1000 sensors

WARNING! **Electric shock!**



Upon opening the housing, live parts are exposed.
→ Always disconnect the controller from power supply before opening the housing!

The controller is protected by a fuse. The fuse holder (which also holds the spare fuse) becomes accessible when the cover is removed. To replace the fuse, pull the fuse holder from the bottom.

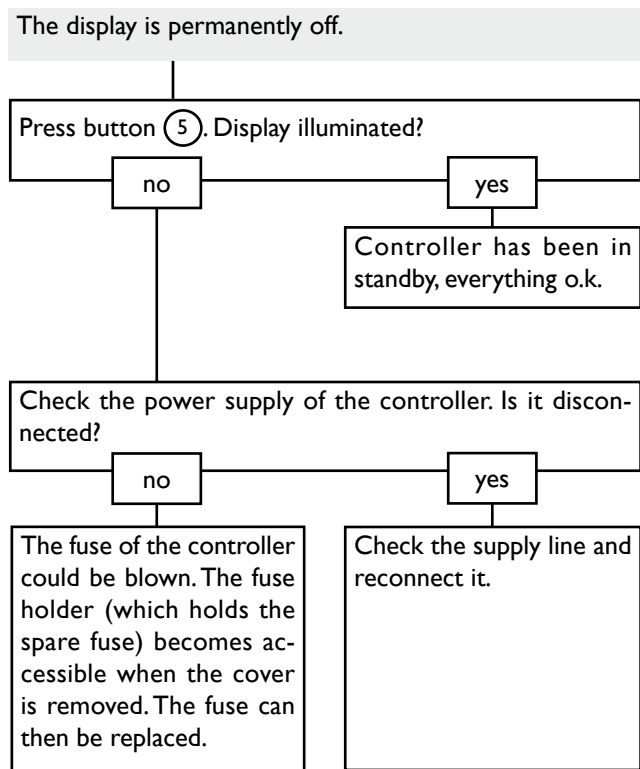

9.1 Miscellaneous

Pump is overheated, but no heat transfer from the collector to the tank, flow and return have the same temperature; perhaps also bubble in the lines.

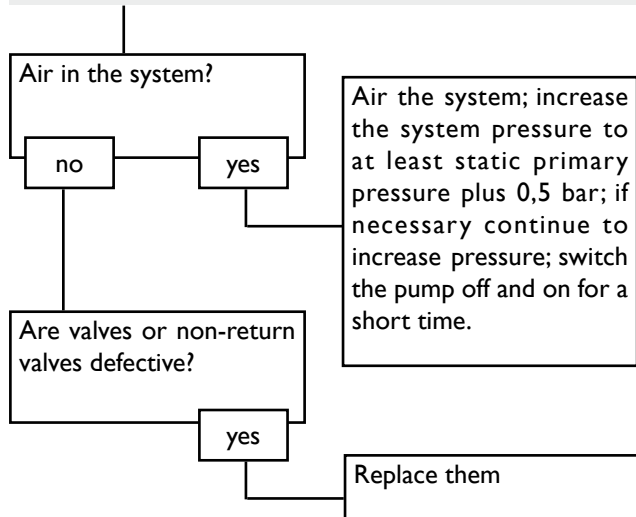

Pump starts for a short moment, switches off, switches on again, etc.

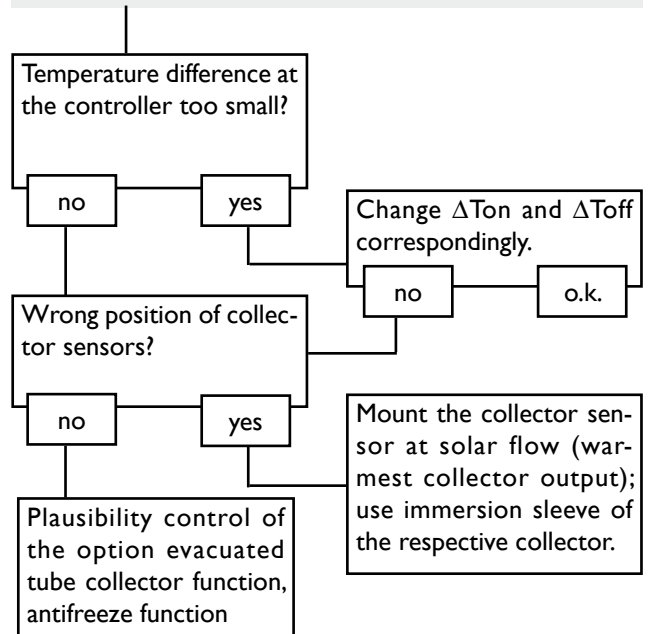

Pump starts up very late.

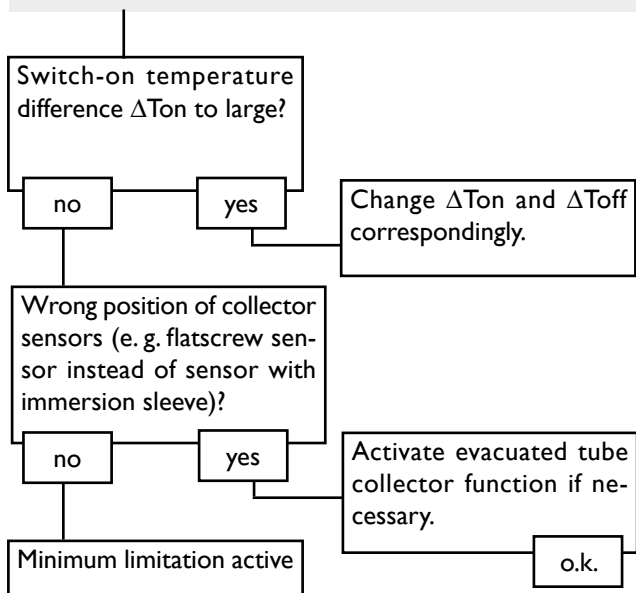

The temperature difference between tank and collector increases enormously during operation; the collector circuit cannot dissipate the heat.

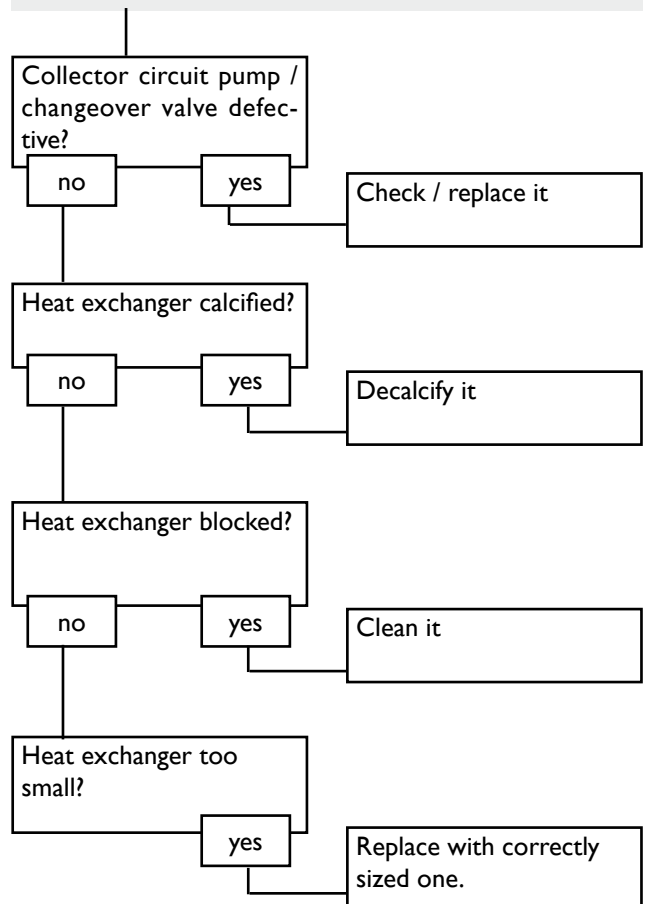

Tanks cool down at night.

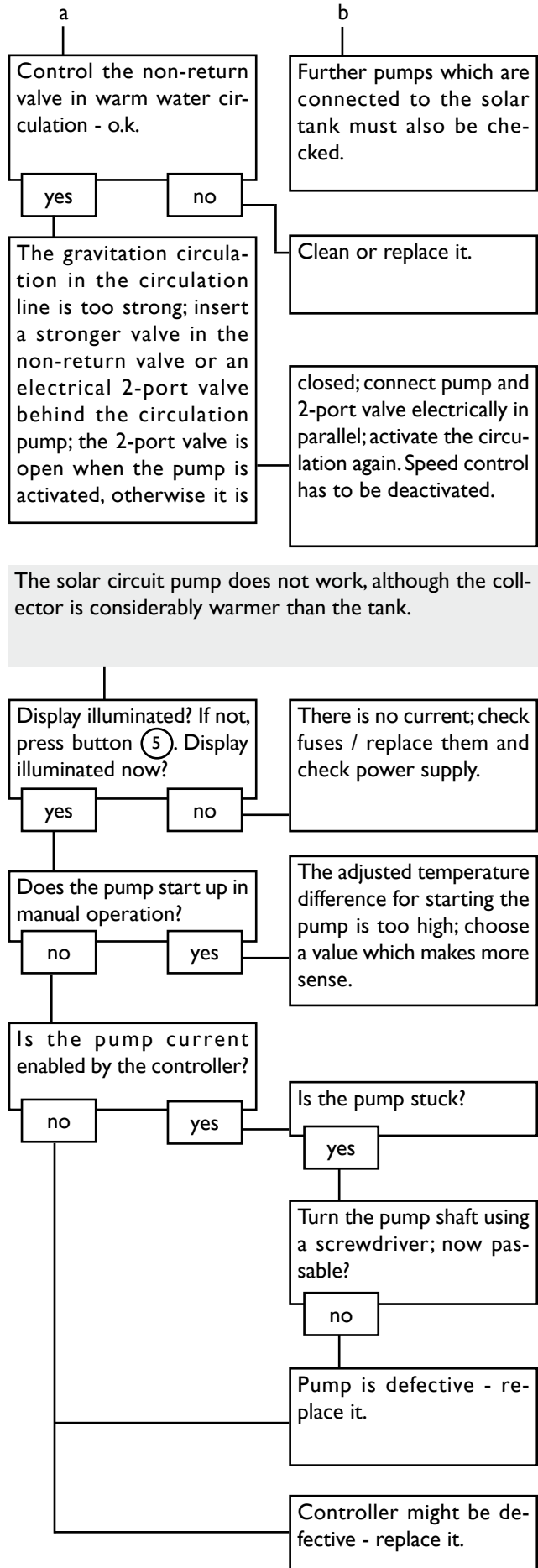
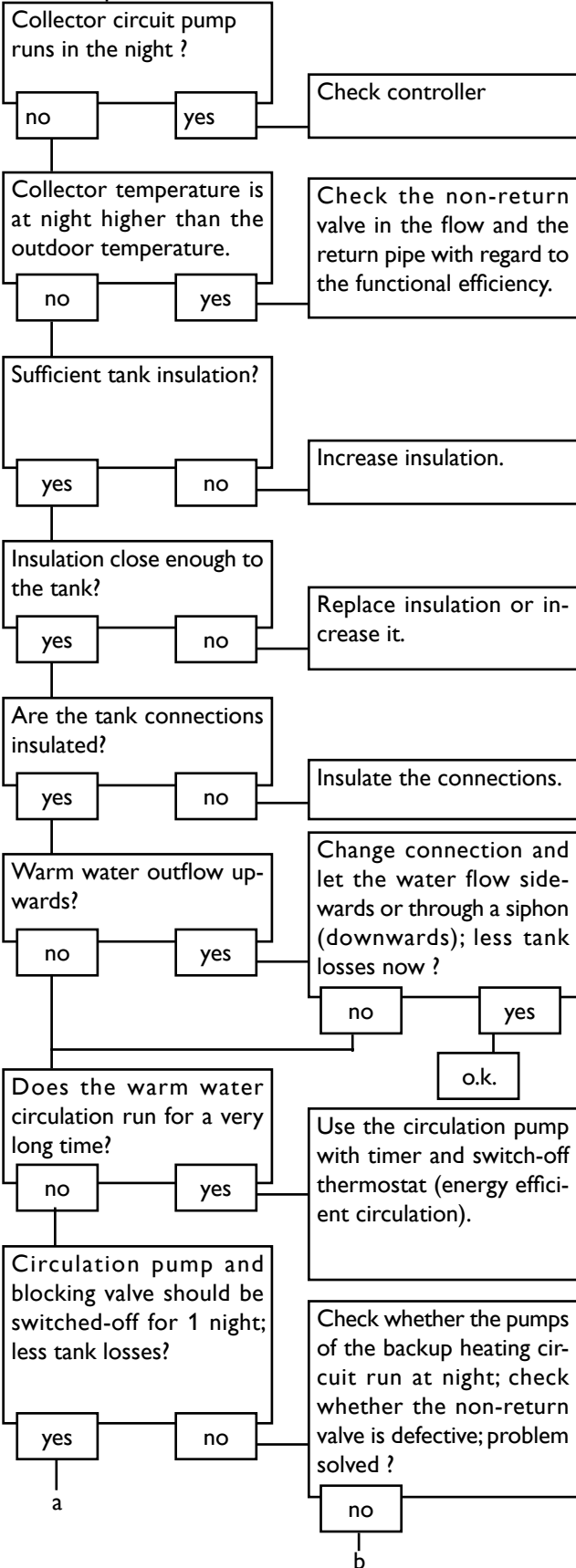

10 Accessories

10.1 Sensors and measuring instruments



Temperature sensors

The product range includes high-precision platinum temperature sensors, flatscrew sensors, outdoor temperature sensors, indoor temperature sensors, cylindrical clip-on sensors, also as complete sensors with immersion sleeve.

Overvoltage protection device

In order to avoid overvoltage damage at collector sensors (e.g. caused by local lightning storms), we recommend the overvoltage protection SP10.

VFS and RPS Grundfos Direct Sensors

The RPS Grundfos Direct Sensor is a sensor for measuring the temperature and the pressure.

The VFS Grundfos Direct Sensor is a sensor for measuring the temperature and the flow rate.

Flowmeter V40

The V40 is a measuring instrument for detecting the flow of water or water/glycol mixtures. After a specific volume has passed, the V40 reed switch sends an impulse to the calorimeter. The heat quantity used is calculated by the calorimeter using these impulses and the measured temperature difference with the help of pre-defined parameters (glycol type, concentration, heat capacity, etc.).

10.2 Interface adapters



VBus® / USB and VBus® / LAN interface adapter

The new VBus® / USB interface adapter is the interface between the controller and a personal computer. With its standard mini-USB port it enables a fast transmission of system data for processing, visualising and archiving as well as the parametrization of the controller via the VBus®. A full version of the ServiceCenter software is included.

The VBus® / LAN interface adapter is designed for the direct connection of the controller to a PC or router. It enables easy access to the controller via the local network of the owner. Thus, controller access, system parametrization and data charting can be effected from every workstation of the network. The VBus® / LAN interface adapter is suitable for all controllers equipped with a VBus®. A full version of the ServiceCenter software is included.

10.3 Visualization modules



Smart Display SD3 / Large Display module GA3

The Smart Display is designed for simple connection to controllers with VBus®. It is used for visualising data issued by the controller: collector temperature, tank temperature and energy yield of the solar thermal system. The use of high-efficiency LEDs and filter glass assures a high optical brilliance and good readability even in poor visibility conditions and from a larger distance. An additional power supply is not required. One module is required per controller.

The GA3 is a completely mounted large display module for visualization of collector- and tank temperatures as well as the heat quantity yield of the solar system via one 6-digit and two 4-digit 7-segment-displays. An easy connection to all controllers with VBus® is possible. The front plate is made of antireflective filterglass and is printed with a light-resistant UV-lacquering. The universal VBus® allows the parallel connection of 8 Large Displays as well as additional VBus® modules.



AM1 Alarm module

The AM1 Alarm module is designed to signal system failures. It is to be connected to the VBus® of the controller and issues an optical signal via the red LED if a failure has occurred. The AM1 also has a dry contact relay output, which can e. g. be connected to a building management system (BMS). Thus, a collective error message can be issued in the case of a system failure. Depending on the controller and the sensors connected, different fault conditions can be signalled, e. g. sensor failures, excess or negative system pressure as well as errors in the flow rate, such as a dry run of the pump.

The AM1 Alarm module ensures that occurring failures can be immediately recognized and repaired, even if the system and the controller are difficult to access or located in a remote place. Thus, the reliability and the stable yield of the system are ensured.

11 Index

A

Antifreeze function 81

B

Blocking protection time, display channel..... 75

Booster function 84

C

Collector cooling 80

Collector emergency shutdown..... 80

Collector temperature, display channel 75

Cooling function..... 85

D

Drainback option 83

Drainback periods, display channel 75

ΔT -regulation..... 78

F

Filling time..... 84

Flow rate, display channel..... 76

G

Grundfos sensors and flow rate monitoring 91

H

Heat dump..... 85

Heat exchange function / solid fuel boiler / return preheating..... 86

Heating period, display channel..... 77

Heat quantity, display channel..... 77

Energy metering 90

HQM sensors..... 91

L

Language..... 93

Loading tank 2..... 79

Low pressure 92

M

Manual mode..... 88

Maximum speed 79

Maximum tank temperature..... 78

Maximum temperature limitation..... 86

Minimum collector limitation..... 80

Minimum speed 79

Minimum temperature limitation 86

Monitoring period, display channel..... 77

O

Operating hours counter 76

Other temperatures, display channel..... 76

Overpressure..... 92

Overrun..... 84

P

Parallel relay 90

Pause control 83

Pressure..... 76

Priority logic..... 82

Pump control 79

Pump speed 76

R

Return preheating..... 87

S

SD card..... 93

Selecting the system 78

Sensor maximum tank temperature..... 79

Solid fuel boiler..... 86

Speed control..... 78

Spreaded loading option..... 83

Stabilization..... 84

Starting time, display channel..... 77

Tank cooling 85

Tank set option..... 82

Tank temperature, display channel 75

System cooling..... 85

T

Temperatures at S3, S4 and S5, display channel..... 75

Thermal disinfection (OTD) 89

Thermal disinfection with starting delay..... 89

Thermostat function 87

Time and date..... 92

Time, display channel..... 77

Time period - switch-on condition..... 84

Evacuated tube collector function 80

U

Unit..... 92

Distributed by:

Stiebel Eltron, Inc.

17 West Street
USA - West Hatfield, MA 01088
Phone: (413) 247-3380
Fax: (413) 247-3369
info@stiebel-eltron-usa.com

Important note

We took a lot of care with the texts and drawings of this manual and to the best of our knowledge and consent. As faults can never be excluded, please note:

Your own calculations and plans, under consideration of the current standards and directions should only be basis for your projects. We do not offer a guarantee for the completeness of the drawings and texts of this manual - they only represent some examples. They can only be used at your own risk. They can only be used at your own risk. No liability is assumed for incorrect, incomplete or false information and / or the resulting damages.

Note

The design and the specifications can be changed without notice.

The illustrations may differ from the original product.

Imprint

This mounting- and operation manual including all parts is copyrighted. Another use outside the copyright requires the approval of Stiebel Eltron, Inc.. This especially applies for copies, translations, micro films and the storage into electronic systems.

Editor: Stiebel Eltron, Inc.